

Unica Campaign V12.1.7 Upgrade Guide



Contents

| | |
|--|-----------|
| Chapter 1. Upgrade overview..... | 1 |
| Planning for the installation of Campaign Analytical Server (with flowchart or Optimize Session execution capabilities)..... | 1 |
| Upgrade roadmap..... | 2 |
| How the installers work..... | 4 |
| Modes of installation..... | 5 |
| Sample response files..... | 6 |
| Correcting the registry file when upgrade installation fails..... | 6 |
| Chapter 2. Planning the Unica Campaign and Unica Optimize upgrade..... | 8 |
| Prerequisites..... | 8 |
| IBM SPSS Modeler Advantage Enterprise Marketing Management Edition replaces PredictiveInsight..... | 10 |
| Backing up Unica Campaign..... | 11 |
| Exporting configuration settings..... | 11 |
| Pre-upgrade check utility..... | 11 |
| Upgrade log..... | 13 |
| Upgrade prerequisites for all Unica products..... | 13 |
| Auto commit requirement for Oracle or DB2@..... | 14 |
| Change in names of user-defined groups and roles..... | 14 |
| Unica Campaign upgrade worksheet..... | 14 |
| Chapter 3. Upgrading Unica Campaign and Unica Optimize..... | 16 |
| Unload unused files from memory (AIX® only)..... | 25 |
| Undeploying and upgrading Unica Campaign..... | 25 |
| SQL upgrade scripts..... | 26 |
| acUpgradeTool..... | 27 |
| Setting environment variables for the upgrade tool..... | 27 |
| Running acUpgradeTool..... | 27 |
| Running segmentUpgrade Tool..... | 29 |
| Chapter 4. Upgrade considerations to Deliver..... | 30 |
| Configuring Unica Deliver..... | 30 |
| Chapter 5. Deploying the Unica Campaign web application..... | 31 |
| Setting the web application session timeout..... | 31 |
| Deploying Unica Campaign on WebSphere Application Server..... | 31 |
| Deploying Campaign on WAS from a WAR file..... | 32 |
| Deploying Campaign on WAS from an EAR file..... | 33 |
| Deploying Unica Campaign on WebLogic..... | 34 |
| Additional configuration required for SSL environments..... | 35 |
| Configuring WebLogic to display reports (UNIX)..... | 36 |
| Deploying Unica Campaign on Tomcat Application Server..... | 36 |
| Starting the Unica Campaign server..... | 37 |
| Starting the Unica Campaign listener manually..... | 37 |
| Installing the Unica Campaign listener as a Windows service..... | 38 |
| Chapter 6. Configuring Unica Campaign and Unica Optimize after deployment..... | 39 |
| Google Chrome and Microsoft Edge configuration..... | 39 |
| Setting the Unica Optimize configuration properties manually..... | 40 |
| Verifying that the Unica Campaign listener is running..... | 41 |
| Setting up the Unica Campaign system user..... | 41 |
| Adding data source properties on the Configuration page..... | 42 |
| Importing data source templates..... | 43 |
| Duplicating a data source template..... | 43 |
| Unica Campaign configuration properties..... | 43 |
| Mapping user tables in Unica Campaign..... | 45 |
| Mapping tables for Unica Optimize..... | 45 |
| Unica Optimize system table mapping reference..... | 46 |
| Unica Optimize contact history table mapping reference..... | 47 |
| Verifying the Unica Campaign installation..... | 47 |
| Verifying the Unica Optimize installation..... | 47 |
| Ensuring that your flowcharts are searchable..... | 48 |
| Setting properties for integration with Unica products..... | 48 |
| Additional configuration for enhanced security..... | 48 |
| Disabling the X-Powered-By flag..... | 48 |
| Configuring a restrictive cookie path..... | 49 |
| Starting the Unica Campaign Advance search agent..... | 49 |
| Chapter 7. Configuring multiple partitions for Unica Campaign..... | 51 |
| How multiple partitions work..... | 51 |
| Setting up multiple partitions..... | 51 |
| Partition superuser..... | 53 |
| Configuring data source properties for partitions..... | 53 |
| Setting up system users for Unica Campaign..... | 55 |
| Using IBM Cognos Reports for multiple partitions..... | 56 |
| Assigning roles, permissions, and groups for partitions..... | 56 |

| | |
|---|-----------|
| Chapter 8. Configuring multiple partitions for Unica Optimize..... | 57 |
| How multiple partitions work..... | 57 |
| Setting up multiple partitions for Unica Optimize..... | 57 |
| Chapter 9. Configuring multiple partitions in Unica Deliver..... | 59 |
| Partitions for Unica Deliver: Overview..... | 59 |
| Roadmap for configuring multiple partitions in Unica Deliver..... | 60 |
| Creating a new partition for Unica Deliver..... | 60 |
| Preparing Unica Deliver system tables for the partition..... | 62 |
| Creating and populating the Unica Deliver system tables manually..... | 63 |
| Configuring a system user to access HCL Unica..... | 64 |
| Enabling Unica Deliver in Unica Campaign for the new partition..... | 65 |
| Specifying the Recipient List Uploader location for Unica Deliver..... | 65 |
| Restarting system components after configuring Unica Deliver..... | 65 |
| Testing Unica Deliver partition configuration and connections..... | 66 |
| Chapter 10. Unica Platform utilities..... | 67 |
| Utilities..... | 69 |
| alertConfigTool..... | 69 |
| configTool..... | 69 |
| datafilteringScriptTool..... | 73 |
| encryptPasswords..... | 75 |
| partitionTool..... | 76 |
| populateDb..... | 78 |
| restoreAccess..... | 79 |
| scheduler_console_client..... | 80 |
| Unica Deliver Response and Contact Tracker (RCT) script..... | 82 |
| The MKService_rct script..... | 83 |
| Chapter 11. Uninstalling Unica Campaign and Unica Optimize..... | 85 |
| Chapter 12. Unica Campaign web application clustering..... | 87 |
| WebSphere clustering guidelines..... | 88 |
| Configure ehcache..... | 89 |
| Chapter 13. Upgrading to a clustered listener environment..... | 93 |
| Supported listener clustering configurations..... | 97 |
| Diagram of listener clustering..... | 98 |
| Shared network location for clustered listeners: campaignSharedHome..... | 99 |
| Index..... | |

Chapter 1. Upgrade overview

An upgrade of Unica Campaign and Unica Optimize is complete when you upgrade, configure, and deploy and configure Unica Campaign and Unica Optimize. The Unica Campaign Upgrade Guide provides detailed information about upgrading, configuring, and deploying Unica Campaign and Unica Optimize.

Use the *Upgrade roadmap* section to obtain a broad understanding about using the Unica Campaign Upgrade Guide.

From v12.0 - Unica Campaign installer installs Unica Optimize. It would get installed by default with the installation of Unica Campaign. Although Optimize is getting installed by default with Campaign, you must install license to run Optimize sessions. Get in touch with technical support team to get Optimize licenses.

In v12.1 - Campaign listener supports execution of Campaign flowcharts as well as Optimize sessions. . While installing Campaign Analytical Server (Listener) - user could select the choice what type of listener to install

- Run Optimize session only
- Run Campaign flowcharts
- Run Optimize Session and Campaign flowcharts

Planning for the installation of Campaign Analytical Server (with flowchart or Optimize Session execution capabilities)

Unica Campaign Analytical server (listener) can serve Campaign flowchart executions or Optimize session executions or run both. Please refer below notes before starting with upgrade of Unica Campaign Analytical server or existing Optimize listener installation from previous supported version. See the following table before you start with the upgrade of Unica Campaign Analytical server or existing Optimize listener installation from previous supported version.

| Upgrading Unica Campaign Listener on the single machine where Campaign listener and Optimize listener are installed. | Upgrading Unica Campaign listener only | Upgrading Unica Optimize listener |
|--|--|--|
| <ul style="list-style-type: none">• While upgrading Campaign listener, select the listener node type as "Run Campaign flowchart and Optimize session both".• This installs single Campaign listener (non-cluster) and this listener can run both Optimize session as well as Campaign flowcharts. | <ul style="list-style-type: none">• While upgrading Campaign listener, select the listener node type as "Run Campaign flowchart only".• This installs single Campaign listener (non-cluster) and this listener can run Campaign flowchart only. | <ul style="list-style-type: none">• While upgrading Optimize listener, select the listener node type as "Run Optimize sessions only".• This installs single Campaign listener (non-cluster) and this listener can run Optimize sessions only. |

You require to upgrade environment, where Optimize listener is installed using Campaign listener node selection as - Run Optimize sessions only. While specifying the path users are required to provide the path of `Optimize_Home` as the Campaign

Home. This helps to detect the earlier version and perform upgrade. On Optimize listener node, you can also install to a new location and copy Optimize_Home/partitions/partition[n]/reports and logs directory to a new installation.

Listener node types are also in applicable in Campaign analytical server cluster mode installation. Users can change the listener node type at any time by changing the configuration under registered listener nodes.

Upgrade roadmap

Use the upgrade roadmap to quickly find the information that you need for upgrading Unica Campaign and Unica Optimize.

You can use the following table to scan the tasks that must be completed for upgrading Unica Campaign and Unica Optimize:

Table 1. Unica Campaign and Unica Optimize upgrade roadmap

| Topic | Information |
|--|--|
| Unica Campaign web application clustering on page 87 | If you are using web application clustering, review this appendix before starting your installation. |
| Upgrading to a clustered listener environment on page 93 | If you are using Unica Campaign listener clustering, review this appendix before starting your installation. |
| Upgrade overview on page 1 | <p>This topic provides the following information:</p> <ul style="list-style-type: none"> • How the installers work on page 4 • Modes of installation on page 5 • "Integration of Unica Campaign and Campaign with Unica Deliver" topic in Campaign Installation guide |
| Planning the Unica Campaign and Unica Optimize upgrade on page 8 | <p>This topic provides the following information:</p> <ul style="list-style-type: none"> • Prerequisites on page 8 • Backing up Unica Campaign on page 11 • Exporting configuration settings on page 11 • Pre-upgrade check utility on page 11 • Upgrade log on page 13 • Upgrade prerequisites for all Unica products on page 13 • Unica Campaign upgrade worksheet on page 14 |
| Upgrading Unica Campaign and Unica Optimize on page 16 | <p>This topic provides the following information:</p> <ul style="list-style-type: none"> • Undeploying and upgrading Unica Campaign on page 25 • SQL upgrade scripts on page 26 • acUpgradeTool on page 27 |

Table 1. Unica Campaign and Unica Optimize upgrade roadmap**(continued)**

| Topic | Information |
|---|--|
| Upgrade considerations to Deliver on page 30 | This topic provides the following information: <ul style="list-style-type: none"> • Prerequisites for upgrading Unica Deliver • Configuring Unica Deliver |
| Deploying the Unica Campaign web application on page 31 | This topic provides the following information: <ul style="list-style-type: none"> • Setting the web application session timeout on page 31 • Deploying Unica Campaign on WebSphere Application Server on page 31 • Deploying Unica Campaign on WebLogic on page 34 • Starting the Unica Campaign server on page 37 |
| Configuring Unica Campaign and Unica Optimize after deployment on page 39 | This topic provides the following information: <ul style="list-style-type: none"> • Verifying that the Unica Campaign listener is running on page 41. • Setting up the Unica Campaign system user on page 41 • Adding data source properties on the Configuration page on page 42 • Unica Campaign configuration properties on page 43 • Mapping user tables in Unica Campaign on page 45 • Verifying the Unica Campaign installation on page 47 • Ensuring that your flowcharts are searchable on page 48 • Setting properties for integration with Unica products on page 48 |
| How multiple partitions work on page 51 | This topic provides the following information: <ul style="list-style-type: none"> • Partition superuser on page 53 • Setting up multiple partitions on page 51 • Assigning roles, permissions, and groups for partitions on page 56 |
| Configuring multiple partitions in Unica Deliver on page 59. | This topic provides the following information: <ul style="list-style-type: none"> • Partitions for Unica Deliver: Overview on page 59 • Roadmap for configuring multiple partitions in Unica Deliver on page 60 • Creating a new partition for Unica Deliver on page 60 |

Table 1. Unica Campaign and Unica Optimize upgrade roadmap

(continued)

| Topic | Information |
|---|--|
| | <ul style="list-style-type: none"> • Preparing Unica Deliver system tables for the partition on page 62 • Configuring a system user to access HCL Unica on page 64 • Enabling Unica Deliver in Unica Campaign for the new partition on page 65 • Specifying the Recipient List Uploader location for Unica Deliver on page 65 • Restarting system components after configuring Unica Deliver on page 65 • Testing Unica Deliver partition configuration and connections on page 66 |
| Unica Platform utilities on page 67 | <p>This topic provides the following information:</p> <ul style="list-style-type: none"> • Utilities on page 69 • Unica Deliver Response and Contact Tracker (RCT) script on page 82 • The MKService_rct script on page 83 |
| Uninstalling Unica Campaign and Unica Optimize on page 85 | <p>This topic provides information about how to uninstall Campaign.</p> |

How the installers work

Use the Unica installer with the Campaign installers when you install Campaign.

The Unica suite installer starts the individual product installers during the installation process.

Use the following guidelines to install Campaign.

- Make sure that the Unica installer and the Campaign installer are in the same directory on the server where you want to install Campaign. When multiple versions of the Campaign installer are present in the directory with the Unica installer, the Unica installer shows the latest version of Campaign on the **HCL Unica Products** screen in the installation wizard.
- If you are planning to install a patch immediately after you install Campaign and Optimize, make sure that the patch installer is in the same directory as that of the Unica and the Campaign installer.

Unica is installed in one of the following directories by default:

- /opt/HCL/Unica (for UNIX™)
- C:\HCL\Unica (for Windows™)

Unica products are installed by default in a subdirectory of the *HCL_home* directory. For example, Unica Platform is installed in the *HCL_Unica_home/Platform* directory.

Campaign is installed in the *HCL_Unica_home/Campaign* directory by default.

Modes of installation

The Unica suite installer can run in one of the following modes: GUI mode, X Window System mode, console mode, or silent mode (also called the unattended mode). Select a mode that suits your requirements when you install Unica Campaign.

For upgrades, you use the installer to perform many of the same tasks that you perform during the initial installation.

GUI X Window System mode

Use the GUI mode for Windows™ or the X Window System mode for UNIX™ to install Unica Campaign by using the graphical user interface.



Note: To launch the installers on Windows 2019 and Windows 2022, server please set parameter - **SET JAVA_TOOL_OPTIONS="-Dos.name=Windows 7"** - on command prompt and then launch the Installers from the same command prompt.

UNIX™ X Window System mode

Use the X Window System mode for UNIX™ to install Unica Campaign by using the graphical user interface.

Console mode

Use the console mode to install Unica Campaign by using the command line window.



Note: To display the Installer screens correctly in console mode, configure your terminal software to support UTF-8 character encoding. Other character encoding, such as ANSI, will not render the text correctly, and some information will not be readable.

Silent mode

Use the silent or unattended mode to install Unica Campaign multiple times. The silent mode uses response files for installation and does not require user input during the installation process.



Note: Silent mode is not supported for upgrade installations in clustered web application or clustered listener environments.

Sample response files

You must create response files to set up a silent installation of Unica Campaign . You can use sample response files to create your response files. The sample response files are included with the installers in the `ResponseFiles` compressed archive.

The following table provides information about sample response files:

Table 2. Description of sample response files

| Sample response file | Description |
|--|---|
| <code>installer.properties</code> | The sample response file for the Unica suite installer. |
| <code>installer_product initials and product version number.properties</code> | The sample response file for the Unica Campaign installer. For example, <code>installer_ucn.n.n.n.properties</code> is the response file of the Unica Campaign installer, where <code>n.n.n.n</code> is the version number. For example, <code>installer_umpn.n.n.n.properties</code> is the response file of the Unica Platform installer, where <code>n.n.n.n</code> is the version number. |
| <code>installer_report pack initials, product initials, and version number.properties</code> | The sample response file for the reports pack installer. For example, <code>installer_urpcn.n.n.n.properties</code> is the response file of the Unica Campaign reports pack installer, where <code>n.n.n.n</code> is the version number. |

Correcting the registry file when upgrade installation fails

If installation fails because the installer could not detect the base version of your installed product, you can correct the registry file as described here.

About this task

The InstallAnywhere Global registry file, named `.com.zerog.registry.xml`, is created when a Unica product is installed. The registry file tracks all installed Unica products, including their features and components, on that server.

1. Locate the `.com.zerog.registry.xml` file.

Depending on the server on which you are installing, the `.com.zerog.registry.xml` file is in one of the following locations.

- On Windows servers, the file is in the `Program Files/Zero G Registry` folder.

`Zero G Registry` is a hidden directory. You must enable the setting to view hidden files and folders.

- On UNIX systems, the file is in one of the following directories.
 - Root user - `/var/`
 - Non-root user - `$HOME/`
- 2. Make a backup copy of the file.
- 3. Edit the file to change all entries that refer to the version of your installed product.

For example, this is a section of the file that corresponds to Unica Plan version 8.6.0.3.

```
<product name="Plan" id="dd6f88e0-1ef1-11b2-accf-c518be47c366"  
version=" 8.6.0.3 " copyright="2013" info_url="" support_url=""  
location="<HCL_Unica_Home>\Plan" last_modified="2013-07-25 15:34:01">
```

In this case, you would change all entries that refer to `version=" 8.6.0.3 "` to the base version, which is 8.6.0.0 in this case.

Chapter 2. Planning the Unica Campaign and Unica Optimize upgrade

You can upgrade your current version of Unica Campaign to bring it up-to-date with the latest features.

- Unica Campaign supports the following upgrade paths:
 - 12.1.x → 12.1.7
 - 12.1.0.x → 12.1.7
- Customers on versions earlier than 8.6.x must:
 - perform a Fast Upgrade from existing version to version 8.6.0 (for more information, see *HCL Unica 8.6.0 Fast Upgrade Guide*).
 - perform a Fast Upgrade from version 8.6.0 to version 12.1.0 (for more information, see *HCL Unica 12.1.0 Fast Upgrade Guide*).
 - perform an in-place upgrade from version 12.1.0 to version 12.1.7.
- Customers on versions earlier than 11.1.x.x can:
 - perform a Fast Upgrade from existing version to version 12.1.0 (for more information, see *HCL Unica 12.1.0 Fast Upgrade Guide*).
 - perform an in-place upgrade from version 12.1.0 to version 12.1.7.
- Customers on versions 11.1.x.x/12.0.x.x can use one of the following options for upgrade:
 - **Option 1**
 - perform an in-place upgrade from existing version to version 12.1.0.
 - perform an in-place upgrade from version 12.1.0 to version 12.1.7.
 - **Option 2**
 - perform a Fast Upgrade from existing version to version 12.1.0 (for more information, see *HCL Unica 12.1.0 Fast Upgrade Guide*).
 - perform an in-place upgrade from version 12.1.0 to version 12.1.7.

Prerequisites

Before you install or upgrade any Unica product, you must ensure that your computer complies with all of the prerequisite software and hardware.

System requirements

For information about system requirements, see the *Recommended Software Environments and Minimum System Requirements* guide.

Network domain requirements

The Unica products that are installed as a suite must be installed on the same network domain to comply with the browser restrictions that are designed to limit the security risks that can occur with cross-site scripting.

JVM requirements

Unica applications within a suite must be deployed on a dedicated Java™ virtual machine (JVM). Unica products customize the JVM that is used by the web application server.

Knowledge requirements

To install Unica products, you must have a thorough knowledge of the environment in which the products are installed. This knowledge includes knowledge about operating systems, databases, and web application servers.

Internet browser settings

Make sure that your internet browser complies with the following settings:

- The browser must not cache web pages.
- The browser must not block pop-up windows.

Access permissions

Verify that you have the following network permissions to complete the installation tasks:

- Administration access for all necessary databases



Note: Administrator must have `CREATE`, `SELECT`, `INSERT`, `UPDATE`, `DELETE`, and `DROP` rights for both tables and views.

- Read and write access to the relevant directory and sub-directories for the operating system account that you use to run the web application server and Unica components.
- Write permission for all files that you must edit.
- Write permission for all directories where you must save a file, such as the installation directory and backup directory if you are upgrading.
- Appropriate read, write, and execute permissions to run the installer.

Verify that you have the administrative password for your web application server.

For UNIX™, all installer files for products must have full permissions, for example, `rwxr-xr-x`.

The following additional permissions are necessary for UNIX™:

- The user account that installs Unica Plan and Unica Platform must be a member of the same group as the Unica Campaign users. This user account must have a valid home directory and have write permissions for that directory.
- All installer files for HCL Unica products must have full permissions, for example, `rwxr-xr-x`.

Points to consider before you install Unica Plan

For Unica Plan installation you are required to consider the following points.

JAVA_HOME environment variable

If a JAVA_HOME environment variable is defined on the computer where you install an Unica product, verify that the variable points to a supported version of JRE. For information about system requirements, see the *Unica Recommended Software Environments and Minimum System Requirements* guide.

If the JAVA_HOME environment variable points to an incorrect JRE, you must clear the JAVA_HOME variable before you run the Unica installers.

You can clear the JAVA_HOME environment variable by using one of the following methods:

- Windows™: In a command window, enter set JAVA_HOME= (leave empty) and press **Enter**.
- UNIX™: In the terminal, enter export JAVA_HOME= (leave empty) and press **Enter**.

You can clear the JAVA_HOME environment variable by running the following command in the terminal:

```
export JAVA_HOME= (leave empty)
```

The Unica installer installs a JRE in the top-level directory for the Unica installation. Individual Unica application installers do not install a JRE. Instead, they point to the location of the JRE that is installed by the Unica installer. You can reset the environment variable after all installations are complete.

For more information about the supported JRE, see the *Unica Recommended Software Environments and Minimum System Requirements* guide.

Unica Platform requirements

You must install or upgrade Unica Platform before you install or upgrade any Unica products. For each group of products that work together, you must install or upgrade Unica Platform only once. Each product installer checks whether the required products are installed. If your product or version is not registered with Unica Platform, a message prompts you to install or upgrade Unica Platform before you proceed with your installation. Unica Platform must be deployed and running before you can set any properties on the **Settings > Configuration** page.



Note: For installations on UNIX, you may require to set the `Djava.awt.headless` property to true in your web application server. The setting is required only when you are unable to view Unica Optimize reports. See the *Unica Campaign Installation Guide* for details. You do not require to prepare any additional data sources for Unica Optimize because Unica Optimize uses the Unica Campaign system tables data source.



Note: For versions 12.0.0 and higher, ensure that you do not select the database type Informix as it is not functional. From version 12.1.0.3 and higher, users can use OneDB database as system tables and user tables. See the *Unica V12.1.0.3 Installation Guide for OneDB* for more details.

IBM SPSS Modeler Advantage Enterprise Marketing Management Edition replaces PredictiveInsight

If you previously used PredictiveInsight, you can no longer use the legacy Model and Score process boxes in Unica Campaign.

After you install Unica Campaign version 9.1.0 or later, the legacy Model and Score process boxes are unconfigured in existing flowcharts. You must manually re-create the predictive models either by using IBM SPSS Modeler Advantage Enterprise Marketing Management Edition or by using the SPSS Model process box.



Note: Legacy Model and Score process boxes are inactive and cannot be run. However, they can be viewed for configuration details.

For more information, see the *Unica Campaign and IBM SPSS Modeler Advantage Enterprise Marketing Management Edition Integration Guide*.

Backing up Unica Campaign

You must back up your current installation of Unica Campaign before upgrading Unica Campaign. Backing up your current installation of Unica Campaign ensures that you can restore your installation of Unica Campaign to a known working state if any issues occur during the upgrade process. You can back up your installation of Campaign manually or automatically when you run the installers.

Complete the following steps to back up your current installation of Unica Campaign manually:

1. Back up your Unica Campaign installation directory. If Unica Deliver is installed, back up your Unica Deliver installation directory.

The Unica Campaign upgrade process installs all files that are required to run Unica Campaign and Unica Deliver. If you have installed Unica Deliver, the Unica Campaign upgrade process upgrades your installation of Unica Deliver when Unica Campaign is upgraded.

2. Back up the system table databases that are used by your existing installation of Unica Campaign and Unica Deliver if Unica Deliver is installed.

See your database documentation for instructions on making backups of your data.

Exporting configuration settings

You can use the configuration settings of your current installation of Unica Campaign for the upgraded version of Unica Campaign. Use the `configTool` utility to export your Unica Campaign configuration parameters before upgrading. Specify and make a note of the unique file name and location of the `exported.xml` file that the `configTool` utility creates, so you can locate the file after the upgrade process is complete.

Pre-upgrade check utility

Before you upgrade Unica Campaign, use the **preUpgradeTool** utility to identify any issues or inconsistencies in the file system and database. Running the utility is optional, but recommended.

The **preUpgradeTool** is installed at the same location as the **acUpgradeTool**. For Windows, the utility is named `preUpgradeTool.bat`. For other operating systems, the utility is named `preUpgradeTool.sh`.

The utility performs the following checks:

- **File existence check:** Verifies the Unica Campaign home directory location. This directory must exist in the file system and be accessible to the utility. This check verifies that all files required for the upgrade, such as the database upgrade script and the configuration file, are available in this directory. If any of the files are not accessible, this check fails.
- **Configuration check:** Verifies accessibility to `campaign_configuration.xml`, which is needed to upgrade the configuration. This task also checks if `campaign_configuration.xml` is a valid xml file. If it is corrupted, the task fails.
- **Platform Configuration accessibility check:** Verifies whether the Unica Platform configuration is accessible.
- **Database upgrade check:** Verifies whether the database details that you provided are valid. The utility accesses the database with your user credentials and verifies that the database includes the Unica Campaign system tables. This check also verifies whether you have Create, Drop, and Alter permissions in the database.
- **Unica Campaign and session `ses` file check:** Each campaign, session, and flowchart has files of type `ses` associated with them. The `.ses` file stores system data that is related to the campaign, session, or flowchart. If a file is missing, the related object is not usable.

Prerequisite

Before you run the **preUpgradeTool**, enter the environment details in the `tools/upgrade/12.1+To12.1.7/setenv` file under your Unica Campaign installation. The file extension is `.bat` (Microsoft Windows) or `or.sh` (other operating systems). You can then run the **preUpgradeTool** utility.

If you have a clustered web application environment, you must set the `CLUSTERED_SHARED_PATH` variable in the `setenv` file to the `campaignSharedHome` path that is defined in the Unica Platform configuration `Affinium|Campaign|campaignClustering`.

For Windows:

```
set CLUSTERED_SHARED_PATH=
```

For Linux:

```
CLUSTERED_SHARED_PATH=
export CLUSTERED_SHARED_PATH
```

Process overview

Consider the following points about the Pre-upgrade check utility:

1. The utility interactively requests information that is required for the upgrade, such as the location of `CAMPAIGN_HOME` and database details.
2. After all of the details are collected, they are verified.
3. The status of each validation step is displayed. All results are also logged.
4. If all checks pass, a success message is displayed with an option to continue with the upgrade.
5. All of the data that you provided is automatically passed to the upgrade script.

What to do next

After the Pre-upgrade check utility is completed, you have the option to continue with the upgrade. If you select `yes`, the `acUpgradeTool` is called and the upgrade is started.

For example:

```
2017-08-07 14:51:29,314 INFO common.Prompter [480] - Pre upgrade finished successfully.
Do you want to continue for Upgrade tool?
```



Note: If you select `yes`, you do not have to run the `acUpgradeTool` again separately.

Upgrade log

`acUpgradeTool` writes processing details, warnings, or errors to a log file. You can adjust the location and verbosity level for the log file by editing the `setenv` script file before you run the upgrade tool. The `setenv` file is stored in the same folder as the upgrade tool.

`ac_upgrade.log` is the default log file. The `ac_upgrade.log` log file is stored in the `logs` folder in the Unica Campaign installation directory.

Check the upgrade log for warnings and errors and rectify the errors before you complete the upgrade.



Note: A `CHRH.log` file is also generated in the same location. The `CHRH.log` file is 0 KB in size and can be ignored.

Upgrade prerequisites for all Unica products

Meet all requirements for permissions, operating system, and knowledge correctly before you upgrade Campaign to ensure a seamless upgrade experience.

Removing response files generated by previous installations

If you are upgrading from a version before 8.6.0, you must delete the response files that are generated by previous Unica Campaign installations. Old response files are not compatible with the 8.6.0 and later installers.

Failure to remove old response files can result in having incorrect data pre-filled in installer fields when the installer is run, or in the installer failing to install some files or skipping configuration steps.

The response file is named `installer.properties`.

The response files for each product are named `installer_productversion.properties`.

The installer creates response files in the directory that you specify during installation. The default location is the home directory of the user.

User account requirement for UNIX™

On UNIX™, the user account that installed the product must complete the upgrade, otherwise the installer fails to detect a previous installation.

32-bit to 64-bit version upgrades

If you are moving from a 32-bit to a 64-bit version of Unica Campaign, ensure that you complete the following tasks:

- Ensure that the database client libraries for your product data sources are 64-bit.
- Ensure that all relevant library paths, for example startup or environment scripts, correctly reference the 64-bit versions of your database drivers.

Unloading unused files from memory on AIX®

For installations on AIX®, run the `slibclean` command that is included with your AIX® installation to unload unused libraries from the memory before you run the installer in the upgrade mode.



Note: You must run the `slibclean` command as a root user.

Backing up custom files

Before starting the upgrade to Unica 12.1.7, backup all the custom files that exist in the `<UNICA_HOME>/jre/` location. If you do not backup the custom files that exist in the `<UNICA_HOME>/jre/` location, you will lose the files because the Unica 12.1.7 upgrade deletes the existing `jre` folder and installs a new `jre` folder containing Oracle JRE files.



Note: If the operating system is IBM AIX, Unica 12.1.7 installs IBM JRE.

Auto commit requirement for Oracle or DB2®

If your Unica Platform system tables are in Oracle or DB2®, you must enable the auto-commit mode for the environment open.

See the Oracle or DB2® documentation for instructions.

Change in names of user-defined groups and roles

You must upgrade Unica Platform before you upgrade Unica Campaign. To avoid problems when you upgrade the Unica Platform, the names of the groups and roles that are created by the user must be different from the names of the groups or roles that are defined by Unica Platform.

If the names are same, you must change the group or role names that you created before the upgrade. For example, if you have created a group or role called Admin, you must change the name, because Admin is a name that is used in Unica Campaign.

Unica Campaign upgrade worksheet

Before running `acUpgradeTool`, you must gather information about your Unica Campaign and Optimize installation.

Run the 12.1.7 installer for Campaign over 12.1 base.

Once, the installation is complete with no errors, update the `setenv.sh/.bat` file inside the 'upgrade' folder from default values to specific installation values for `JAVA_HOME`, `CAMPAIGN_HOME`, `JDBC_Classpath`, etc.

After 12.1.7, no need to update the `setenv.sh/.bat` file as the installer will not be replace with default values.

Gather the following information about your Unica Campaign and Optimize installation :

- Fully qualified path of your Unica Campaign installation directory (`CAMPAIGN_HOME` in the `setenv` file)
- For a multi-partition upgrade, the names of the partitions to be upgraded
- Connection information for the target Campaign system (URL and port)
- Connection type (JDBC) and location of the `JAR` files
- Java™ class name for the JDBC driver
- JDBC URL
- Additional properties required by the JDBC driver, if any
- User name and password for the target system tables database
- Catalog (or database) for the target system tables
- Schema for the target system tables
- Version of Unica Campaign you are upgrading from
- Full or relative path of the Unica Campaign configuration file (`campaign_configuration.xml`). This file is located in the `conf` directory under your Unica Campaign installation.

Chapter 3. Upgrading Unica Campaign and Unica Optimize

You can upgrade Unica Campaign and Unica Optimize to version 12.0 from version 11.1.0 only.

About this task

Table 3.

| Upgrading from version | Details |
|------------------------|--|
| Earlier than 8.6.x | <p>To upgrade from a version earlier than 8.6.x, complete the following steps:</p> <ol style="list-style-type: none"> 1. Upgrade to version 8.6 by following the instructions in the upgrade chapter of the <i>Unica Campaign 8.6 Installation Guide</i>. 2. Upgrade to version 10.0 by following the instructions in the <i>Unica Campaign 10.0 Upgrade Guide</i>. 3. Upgrade to version 10.1 by following the instructions in the <i>Unica Campaign 10.1 Upgrade Guide</i>. 4. Upgrade to version 11.0.1 by following the instructions in the <i>Unica Campaign 11.0.1 Upgrade Guide</i>. 5. Upgrade to version 11.1 by following the instructions in Unica Campaign 11.1 Upgrade guide. 6. Upgrade to version 12.0 by following the instructions in Unica Campaign 12.0 Upgrade guide. 7. Upgrade to version 12.1 by following the instructions in this guide. 8. Upgrade to version 12.1.2 by following the instructions in this guide. 9. Upgrade to version 12.1.3 by following the instructions in this guide. 10. Upgrade to version 12.1.4 by following the instructions in this guide. 11. Upgrade to version 12.1.5 by following the instructions in this guide. 12. Upgrade to version 12.1.6 by following the instructions in this guide. 13. Upgrade to version 12.1.7 by following the instructions in this guide. |
| 8.6.x and above | <p>To upgrade from version 8.6.x and above, complete the following steps:</p> <ol style="list-style-type: none"> 1. Upgrade to version 10.0 by following the instructions in the <i>Unica Campaign 10.0 Upgrade Guide</i>. 2. Upgrade to version 10.1 by following the instructions in the <i>Unica Campaign 10.1 Upgrade Guide</i>. 3. Upgrade to version 11.0.1 by following the instructions in the <i>Unica Campaign 11.0.1 Upgrade Guide</i>. 4. Upgrade to version 11.1 by following the instructions in Unica Campaign 11.1 Upgrade guide. 5. Upgrade to version 12.0 by following the instructions in Unica Campaign 12.0 Upgrade guide. 6. Upgrade to version 12.1 by following the instructions in this guide. |

Table 3. (continued)

| Upgrading from version | Details |
|------------------------|--|
| | <ol style="list-style-type: none"> 7. Upgrade to version 12.1.2 by following the instructions in Unica Campaign 12.1.2 Upgrade guide. 8. Upgrade to version 12.1.3 by following the instructions in Unica Campaign 12.1.3 Upgrade guide. 9. Upgrade to version 12.1.4 by following the instructions in Unica Campaign 12.1.4 Upgrade guide. 10. Upgrade to version 12.1.5 by following the instructions in Unica Campaign 12.1.5 Upgrade guide. 11. Upgrade to version 12.1.6 by following the instructions in Unica Campaign 12.1.6 Upgrade guide. 12. Upgrade to version 12.1.7 by following the instructions in Unica Campaign 12.1.7 Upgrade guide. |
| 10.0 and above | <p>To upgrade from version 10.0.x and above, complete the following steps:</p> <ol style="list-style-type: none"> 1. Upgrade to version 10.1 by following the instructions in the Unica Campaign 10.1 Upgrade Guide. 2. Upgrade to version 11.0.1 by following the instructions in the Unica Campaign 11.0.1 Upgrade Guide. 3. Upgrade to version 11.1 by following the instructions in Unica Campaign11.1 Upgrade guide. 4. Upgrade to version 12.0 by following the instructions in Unica Campaign 12.0 Upgrade guide 5. Upgrade to version 12.1 by following the instructions in this guide. 6. Upgrade to version 12.1.2 by following the instructions in this guide. 7. Upgrade to version 12.1.3 by following the instructions in this guide. 8. Upgrade to version 12.1.4 by following the instructions in this guide. 9. Upgrade to version 12.1.5 by following the instructions in this guide. 10. Upgrade to version 12.1.6 by following the instructions in this guide. 11. Upgrade to version 12.1.7 by following the instructions in this guide. |
| 10.1.x.x and above | <p>To upgrade from version 10.1.x.x , complete the following steps:</p> <ol style="list-style-type: none"> 1. Upgrade to version 11.0.1 by following the instructions in the Unica Campaign 11.0.1 Upgrade Guide. 2. Upgrade to version 11.1 by following the instructions in Unica Campaign11.1 Upgrade guide. 3. Upgrade to version 12.0 by following the instructions in Unica Campaign 12.0 Upgrade guide. 4. Upgrade to version 12.1 by following the instructions in this guide. |

Table 3. (continued)

| Upgrading from version | Details |
|------------------------|---|
| | <ol style="list-style-type: none"> 5. Upgrade to version 12.1.2 by following the instructions in this guide. 6. Upgrade to version 12.1.3 by following the instructions in this guide. 7. Upgrade to version 12.1.4 by following the instructions in this guide. 8. Upgrade to version 12.1.5 by following the instructions in this guide. 9. Upgrade to version 12.1.6 by following the instructions in this guide. 10. Upgrade to version 12.1.7 by following the instructions in this guide. |
| 11.0 | <p>To upgrade from version 11.0, complete the following steps:</p> <ol style="list-style-type: none"> 1. FastUpgrade to version 11.0.1 by following the instructions in Unica 11.0.1 Fast Upgrade Guide. 2. Upgrade to version 11.1 by following the instructions in Unica Campaign 11.1 Upgrade guide. 3. Upgrade to version 12.0 by following the instructions in Unica Campaign 12.0 Upgrade guide. 4. Upgrade to version 12.1 by following the instructions in this guide. 5. Upgrade to version 12.1.2 by following the instructions in this guide. 6. Upgrade to version 12.1.3 by following the instructions in this guide. 7. Upgrade to version 12.1.4 by following the instructions in this guide. 8. Upgrade to version 12.1.5 by following the instructions in this guide. 9. Upgrade to version 12.1.6 by following the instructions in this guide. 10. Upgrade to version 12.1.7 by following the instructions in this guide. |
| 11.0.1.x version | <p>To upgrade from version 11.0.1.x , complete the following steps:</p> <ol style="list-style-type: none"> 1. Upgrade to version 11.1 by following the instructions the Unica Campaign 11.1 Upgrade Guide. 2. Upgrade to version 12.0 by following the instructions in Unica Campaign 12.0 Upgrade guide. 3. Upgrade to version 12.1 by following the instructions in this guide. 4. Upgrade to version 12.1.2 by following the instructions in this guide. 5. Upgrade to version 12.1.3 by following the instructions in this guide. 6. Upgrade to version 12.1.4 by following the instructions in this guide. 7. Upgrade to version 12.1.5 by following the instructions in this guide. 8. Upgrade to version 12.1.6 by following the instructions in this guide. 9. Upgrade to version 12.1.7 by following the instructions in this guide. |
| 11.1.x.x version | <p>For version 11.1.x.x, you can perform one of the following options:</p> |

Table 3. (continued)





| Upgrading from version | Details |
|------------------------|--|
| | <p> Note: In case of an in-place upgrade, install the new version into the same directory where Unica Campaign is installed, so that Unica Campaign can detect the upgrade.</p> <ul style="list-style-type: none"> • Option 1 <ul style="list-style-type: none"> ◦ perform a in-place upgrade from existing version to version 12.1.0. ◦ perform a in-place upgrade from version 12.1.0 to version 12.1.5. • Option 2 <ul style="list-style-type: none"> ◦ perform a Fast Upgrade from existing version to version 12.1.0 (for more information, see <i>HCL Unica 12.1.0 Fast Upgrade Guide</i>). ◦ perform a in-place upgrade from version 12.1.0 to verison 12.1.5. |
| 12.0.x.x version | <p>For version 12.0.x.x, you can perform one of the following options:</p> <p> Note: In case of an in-place upgrade, install the new version into the same directory where Unica Campaign is installed, so that Unica Campaign can detect the upgrade.</p> <ul style="list-style-type: none"> • Option 1 <ul style="list-style-type: none"> ◦ perform a in-place upgrade from existing version to version 12.1.0. ◦ perform a in-place upgrade from version 12.1.0 to version 12.1.6. • Option 2 <ul style="list-style-type: none"> ◦ perform a Fast Upgrade from existing version to version 12.1.0 (for more information, see <i>HCL Unica 12.1.0 Fast Upgrade Guide</i>). ◦ perform a in-place upgrade from version 12.1.0 to verison 12.1.6. |

Table 3. (continued)

| Upgrading from version | Details |
|------------------------|--|
| |  Note: MariaDB system tables upgrade is supported from v12.0.0. |
| 12.1.x version | Upgrading from Unica Campaign 12.1.x is considered an in-place upgrade. You must install the new version into the same directory where Unica Campaign is installed, so that Unica Campaign can detect the upgrade. |

 **Note:** If you plan to upgrade to a clustered Unica Campaign listener configuration, see the [Upgrading to a clustered listener environment on page 93](#).

Tomcat and Jboss application servers are supported from 11.1 version, so if you plan to use any of these application servers refer the Unica Campaign Installation guide "**Chapter 3. Preparing data sources for Campaign**" for creating datasource and "**Chapter 7. Deploying the Campaign web application**" for deployment of Unica Campaign on Jboss and Tomcat application server.

 **Note:** If you are planning to implement SSL in Campaign application, see the Platform Administrator guide>Implementation of one-way SSL section.

If you have configured Campaign application with GSKIT, you must generate new certificate using Open SSL and configure SSL with the steps mentioned in Platform Administrator guide>Implementation of one-way SSL section.



The following steps provide an overview of the tasks that you must complete to upgrade Unica Campaign and Optimize:

1. For installations on AIX®, unload unused libraries from memory before you run the installer in upgrade mode.
2. Undeploy Unica Campaign.
3. Run the Unica installer and the Unica Campaign installer in the Unica Campaign installation directory. The installer automatically runs in upgrade mode. Follow the instructions provided in the following table.

Table 4. Unica Campaign Installer GUI

| Window | Description |
|-----------------------------------|--|
| Introduction | This is the first window of the Campaign installer. You can open the Campaign installation and upgrade guides from this window. Click Next . |
| Software License Agreement | Carefully read the agreement. Use Print to print the agreement. Click Next after you accept the agreement. |

| Window | Description |
|-------------------------------------|--|
| Installation Directory | <p>Click Choose to browse to the directory where you want to install Campaign and Optimize.</p> <p>Click Next.</p> |
| Components | <p>Select the components that you want to install.</p> <p>When you select the components, the installer displays information about the components.</p> <p>Click Next.</p> |
| Single or Multiple Listeners | <p>Select Non-clustered listener configuration (single node)</p> <p> Note: If you are doing a clustered listener installation, see the Appendix B in the Installation Guide for instructions on installation.</p> <p>Click Next.</p> |
| Listener Node Properties | <p>You can choose to install Campaign Analytical Server to server only Campaign, only Optimize, or both. You can either select one of the following options or both and click Next..</p> <ul style="list-style-type: none"> • Run Campaign flowcharts only • Run Optimize sessions only • Run Campaign flowchart and Optimize session <p>If you have an existing version of Optimize installed on your system, select Yes and provide the existing Optimize installation location under Optimize Home box. Click Next.</p> |
| Overwrite Confirmation | <p>Click Next to overwrite the existing installation and Previous to return to the previous step.</p> |
| Default locale | <p>Select a default locale for your installation. English is selected by default.</p> <p>Click Next.</p> |
| Campaign Database Setup | <p>Select one of the following options for setting up the Campaign database:</p> <ul style="list-style-type: none"> • Automatic database setup • Manual database setup |

| Window | Description |
|--|---|
| | <p>If you select Automatic database setup, select Run Unicode SQL Script if your system tables are configured for Unicode.</p> <p>Click Next.</p> |
| <p>Campaign Database Type</p> | <p>Select the appropriate database type.</p> <p>Click Next.</p> |
| <p>Campaign Database Connection</p> | <p>Enter the following details for the Campaign database:</p> <ul style="list-style-type: none"> • Database host name • Database port • Database system ID (SID) • Database user name • Password <p> Important: If Unica products are installed in a distributed environment, you must use the machine name rather than an IP address in the navigation URL for all of the applications in the suite. Also, if you are on a clustered environment and choose to use ports that are different from the default ports 80 or 443 for your deployment, do not use a port number in the value of this property.</p> <p>Click Next.</p> |
| <p>JDBC Connection</p> | <p>Review and confirm the JDBC connection.</p> <p>Click Next.</p> |
| <p>Campaign Connection Settings</p> | <p>Enter the following connection settings:</p> <ul style="list-style-type: none"> • Network domain name <p> Note: When you add the network domain name, you might see the following message:</p> <div style="border: 1px solid #ccc; background-color: #f0f0f0; padding: 5px; margin-top: 10px;"> <pre>Warning-Server name includes domain name, final URL contains several occurrences of domain name</pre> </div> |

| Window | Description |
|------------------------------------|--|
| |  Select Modify to change the domain name or click Cancel to cancel the message. <ul style="list-style-type: none"> • Host name • Port number - If you have load balancer or HTTP server, and during installation you specify host name of that and do not left the port empty. Select the Use secure connection check box if necessary. Click Next . |
| Platform Utilities Settings | Review and confirm or change the following information for connecting to the Unica Platform database: <ul style="list-style-type: none"> • JDBC driver class • JDBC connection URL • JDBC driver classpath Click Next to validate your entries and to go to the next window. |
| Datasource creation | The installer can create the JDBC data source for one partition in your web application server (WebSphere® or WebLogic). This data source is required to enable the Campaign web application to connect to the Campaign system tables. You have the option to skip this step in the installer and create the data source in the administration console of your web application server after installation is complete. <p>If you select the Create Campaign Datasource check box, the installer creates the data source using information you provide..</p> <ul style="list-style-type: none"> • Your application server must be running. • Enter any name for the datasource. The installer creates the JNDI name automatically (campaignPartition1DS). <ul style="list-style-type: none"> • Enter the directory in which the application server is installed. |

| Window | Description |
|---|--|
| | <p>For WebSphere®, this is the directory that contains the <code>profiles</code> directory. You must restart WebSphere® after the installer finishes and before you use this data source.</p> <p>For WebLogic, this is the directory that contains the <code>common</code> directory.</p> <p>Click Next to go to the next window.</p> |
| <p>Application server information (WebSphere®)</p> | <p>Applies only if your application server is WebSphere®.</p> <ul style="list-style-type: none"> • Enter the application server profile where you plan to deploy Campaign. • Enter the name of the server in the profile. • If security is enabled in WebSphere, enter the administrator user ID and password. <p>Click Next to go to the next window.</p> |
| <p>Application server information (WebLogic)</p> | <p>Applies only if your application server is WebLogic.</p> <p>Enter the domain server name and the administrator user ID and password. If SSL is enabled, enter the HTTP port for the domain.</p> <p>Note that you must add the database driver classpath to WebLogic in the WebLogic administration console.</p> <p>Click Next to go to the next window.</p> |
| <p>Preinstallation Summary</p> | <p>Review and confirm the values that you added during the installation process.</p> <p>Click Install to start the installation process.</p> <p>The Campaign installer opens.</p> |
| <p>Installation Complete</p> | <p>Click Done to close the Unica Platform installer and go back to the Unica installer.</p> |

4. Run the pre-upgrade utility in pre-upgrade mode (`preUpgradeTool.bat` or `preUpgradeTool.sh`).
5. Run the upgrade tool (`acUpgradeTool`).
6. You must clear the browser cache after you complete the upgrade. You must also clear the browser cache after you apply any Unica Campaign fix pack or Unica Campaign interim fix that updates the Unica Campaign application.
7. Upgrade your reports as explained in the *Unica Reports Installation and Configuration Guide*.

Important notes for Unica Deliver users

Unica Deliver is installed or upgraded as part of Unica Campaign. If you currently use or plan to use Unica Deliver, see [Upgrade considerations to Deliver on page 30](#).



Note: When you upgrade Unica Deliver, there is no need to select **Automatic DB Setup**. This option is intended only for new installations, when the Unica Deliver system tables do not already exist.

Unload unused files from memory (AIX® only)

About this task

For installations on AIX®, run the `slibclean` command included with your AIX® installation to unload unused libraries from memory before you run the installer in upgrade mode. Note that you must be root to run the `slibclean` command for this purpose.

Undeploying and upgrading Unica Campaign

Before upgrading Unica Campaign, you must undeploy your current installation of Unica Campaign.

Complete the following steps to undeploy the current installation of Unica Campaign:

1. Stop the Unica Campaign utilities (unica_*) that might be running. For instructions, see the *Unica Campaign Administrator's Guide*.

If you skip this step, the installer detects if any processes are running and requests that you stop them.

2. Stop the Unica Campaign listener using one of the following methods:

Choose from:

- On UNIX™, run the following command as root: `./rc.unica_ac stop`
- On Windows™, go to the Unica Campaign `bin` directory and run the following command: `svrstop -p <port>`, where `<port>` is the port on which the listener is running. By default, `<port>` is 4664.

If you are prompted for the `CAMPAIGN_HOME` environment variable, use the following command to set the `CAMPAIGN_HOME` environment variable: `set CAMPAIGN_HOME=C:\installation_path\Campaign`.

After you set the `CAMPAIGN_HOME` environment variable, run the setup as shown here, then run the `svrstop` command again.

3. Follow the instructions in your web application server to undeploy the `Campaign.war` file, and save or activate all changes.
4. Shut down and restart the web application server to release the lock on the `Campaign.war` file.

What to do next

After you undeploy your current installation of Unica Campaign, you can run the Unica installer in upgrade mode. Use the following guidelines to run the installer in upgrade mode:

- To ensure that the Unica installer runs in the upgrade mode, select the same directory as your current installation when you run the installer. The installer detects your existing version of Unica Campaign and prompts you to confirm the upgrade.
- When upgrading, do not select the installer option for **Automatic DB Setup**. This option is intended for new installations, not upgrades.

- If you are rerunning the installer on a system where other HCL products are installed, select only Unica Campaign in the installer during the upgrade process.
- If a response file was previously created and you run in unattended mode, the installer uses the installation directory that was previously set. If you want to upgrade by using the unattended mode when no response file exists, create a response file by running the installer manually for your first installation, and be sure to select your current installation directory in the installation wizard.
- If you have a distributed system where the Campaign listener is installed on one server, and J2EE is installed on a different server, complete the following tasks to upgrade Unica Campaign:
 1. Run the Unica Campaign installer on the server where the Unica Campaign listener is installed. Make sure that you select the **Campaign Server** option in the **Campaign Components** window of the installer.
 2. Run the Unica Campaign installer on the server where J2EE is installed. Make sure that you clear the Campaign Server option in the **Campaign Components** window of the installer.

You can create an EAR file after the upgrade process. To see more information about creating an EAR file, see *Unica Campaign Installation Guide*

After you run the Unica installer in the upgrade mode, run acUpgradeTool to continue the upgrade process.



Note: When you upgrade to Campaign 12.1 from Campaign 11.1.X or before, scheduled flowcharts are not getting executed after upgrade. Use the quartzjobtool to update scheduler jobs. Execute platform_home/tools/bin/quartzjobtool.sh (Unix) or quartzjobtool.bat (Windows).

SQL upgrade scripts

Use SQL upgrade scripts to upgrade your installation of Unica Campaign according to your database type.

The SQL upgrade scripts are in the *Campaign_Home/tools/upgrade/12.1+To12.1.7* folder. Use one of the scripts from the following table according to your database type:

Table 5. SQL upgrade scripts according to database type

| SQL upgrade script | Database type |
|-------------------------------|---|
| ac_upgrade_db2.sql | DB2® upgrade script (non-Unicode) |
| ac_upgrade_db2_unicode.sql | DB2® upgrade script (Unicode) |
| ac_upgrade_oracle.sql | Oracle upgrade script (non-Unicode) |
| ac_upgrade_oracle_unicode.sql | Oracle upgrade script (Unicode) |
| | |
| ac_upgrade_sqlsvr.sql | MS SQL Server upgrade script (non-Unicode) |
| ac_upgrade_sqlsvr_unicode.sql | MS SQL Server upgrade script (Unicode) |

Example

If you are using Optimize and upgrading prior to v12.0 versions please execute the extra indexes using below SQL:

aco_extra_indexes_db2.sql

aco_extra_indexes_mariadb.sql

aco_extra_indexes_ora.sql

aco_extra_indexes_sqlsvr.sql

You will not need to execute this script if you are installing Optimize as a clean install.

acUpgradeTool

acUpgradeTool updates the Unica Campaign system tables and modifies your user data to work with the new version of Unica Campaign. You can run acUpgradeTool after you run the Unica installer in the upgrade mode.

Setting environment variables for the upgrade tool

Before you run acUpgradeTool, edit the `setenv` file to set the environment variables that are required by the acUpgradeTool tool.

1. Open `setenv.bat` (Windows) or `setenv.sh` (UNIX) in a text editor.

The `setenv` file is stored in the directory where you installed the upgrade tools, for example, `Campaign_Home/tools/upgrade/12.1+To12.1.7`.

2. Follow the instructions in the `setenv` file to supply the values that are relevant to your installation.

The following table contains a list of the variables:

Table 6. Variables in the `setenv` file:

| Variable | Description |
|---------------------------|--|
| <code>JAVA_HOME</code> | Required. Root directory of the JDK used by your Unica Campaign installation. |
| <code>JDBCDRIVER_C</code> | Required. |
| <code>CLASSPATH</code> | Full path for the JDBC drivers, including the <code>.jar</code> file. |
| Other variables | There are many optional variables you can set. For example: <ul style="list-style-type: none"> • To run Unicode script, set <code>IS_UNICODE_SCRIPT = YES</code> • To avoid memory errors when running the upgrade tool, specify larger Java™ heap memory sizes in the <code>JAVA_OPTIONS</code> environment variable. For instructions, see the <code>setenv</code> file. |

Running acUpgradeTool

To upgrade Unica Campaign, run acUpgradeTool after you run the installers in the upgrade mode.

Before you begin

To successfully run acUpgradeTool, verify the following information:

- The `setenv` file is customized with the information that the upgrade tool requires.
- The upgrade tools are installed on the computer where you run them. If your setup is distributed, the tools must be installed on the computer where the Unica Campaign web application is installed. If you did not install the upgrade tools during the Unica Campaign installation, run the installer again and select only the **Upgrade Tools** option.
- The appropriate database client executable file (`db2`, `osql`, or `sqlplus`) for the Unica Campaign system tables data source is accessible in the `PATH` of the user who runs the upgrade tool.

Complete the following steps before you run the upgrade tool:

1. Run the Unica Campaign installer in upgrade mode.
2. Redeploy Unica Campaign.
3. Restart RCT if you are using Unica Deliver.
4. Modify the SQL script if required, and gather information to enter when you run the tool.

About this task



Note: If you have multiple partitions, you must configure and run the upgrade tool once for each partition.

Complete the following actions to run `acUpgradeTool` and complete the upgrade process:

1. Start the web application server on the target system and the Campaign web application.
2. Make sure that the Unica Campaign listener is stopped.

Stop the Unica Campaign utilities (`unica_*`) that might be running. For instructions, see the Unica Campaign Administrator's Guide.
3. Run the upgrade tool in the path where you installed Unica Campaign, `Campaign_Home/tools/upgrade/12.1 To 12.1.7/acUpgradeTool`
4. Enter the requested information at the prompts to upgrade your system tables for the new version of Unica Campaign.
5. Complete one of the following steps to restart the Unica Campaign listener:

Choose from:

- On Windows™, run the `cmpServer.bat` file in the `bin` directory under your Unica Campaign installation.

Choose from:

- On UNIX™, run the following command as root:

```
./rc.unica_ac start
```

What to do next

Complete the following steps after you have run `acUpgradeTool`:

1. Restart the Unica Campaign listener, also known as the server.
2. If you are using Deliver, restart the RCT.

To restart the RCT manually, use the `rct start` command. The RCT script is in the `bin` directory under your Unica Deliver installation.

To restart the RCT every time you restart the operating system of the machine where the RCT is installed, add the RCT as a service. For instructions, see [The MKService_rct script on page 83](#).



Note: When you restart the RCT as a service, you must manually restart the RCT the first time.

Running segmentUpgrade Tool

Run segmentUpgrade Tool separately for each partition, after doing table mapping in respective partition. The utility scans all the session files available in campaign and session directory in specified partition. It updates internal references used to display segment update alert

Procedure

Complete the following actions to run segmentUpgrade Tool:

1. Start the web application server on the target system and the Campaign web application.
2. Script modification

[On Windows]

edit "segmentUpgrade.bat" and replace "%SCRIPT_DIR%\unica_acsesutil.exe" with "%CAMPAIGN_HOME%\bin\unica_acsesutil.exe"

[On Linux]

edit "segmentUpgrade.sh" and replace "\${SCRIPT_DIR}/unica_acsesutil" with "\${CAMPAIGN_HOME}/bin/unica_acsesutil"

3. Run the upgrade tool in the path where you installed Unica Campaign, \${CAMPAIGN_HOME}/tools/upgrade/12.1+To12.1.7/segmentUpgrade

e.g. segmentUpgrade.bat partition1 -u asm_admin -p ""



Note: If any of .ses file/flowcharts have issues while processing, list of those flowchart will appear at the end of the segmentUpgrade tool run. While running this tool, if user stops the segmentUpgrade tool run then in the next run it will resume where it left.



Note: On Windows, upon completion of script run, you might see below error on screen, which can be ignored.

FINDSTR: Cannot open unprocess.txt

Below 0 lines are the unprocessed session files

The system cannot find the file specified.

Chapter 4. Upgrade considerations to Deliver

Unica Deliver works with Unica Campaign version 12.1.

Configuring Unica Deliver

To configure to the latest version of Unica Deliver, you must upgrade Unica Campaign to the same version.

- When changes to the Unica Deliver system tables are part of an upgrade, HCL provides the required schema upgrade scripts and procedures. Run the truncate scripts before starting with the upgrade. Users must take the backup of tables, if required. The delete scripts are laid down with files named : `ace_op_delete_systab_<db_type>.sql` located at `<Campaign_Home>/Deliver/ddl/upgrade`.
- You must set the `deliverPluginJarFile` for Deliver. Complete the following steps.
 1. Login to Platform and navigate to **Settings > configuration**.
 2. Navigate to `Affinium | Campaign | partitions | partition1 | Deliver` and provide value for `deliverPluginJarFile` as below. The token `<Campaign_home>` must be replaced with the actual value of `Campaign_Home`.

```
deliverPluginJarFile <CAMPAIGN_HOME>/Deliver/plugin/deliverplugin.jar
```
 3. Restart Campaign app server.

To use Unica Deliver to send email, you must contact HCL to purchase a hosted email subscription. For information about how to configure Unica Deliver after you purchase an email subscription, see the Unica Deliver Startup and Administrator's Guide.

Start the Response and Contact tracker (RCT) after the upgrade in one of the following ways.

Starting the RCT manually

Start the RCT manually, use the `rct start` command. The RCT script is stored in the `bin` directory under your Unica Deliver installation. For more information, see [Unica Deliver Response and Contact Tracker \(RCT\) script on page 82](#).

Starting the RCT as a service

To start the RCT every time that you restart the computer where the RCT is installed, add the RCT as a service.



Note: When you start the RCT as a service, you must manually start the RCT the first time.

Chapter 5. Deploying the Unica Campaign web application

You can deploy the Unica Campaign web application by using an EAR file or you can deploy the individual WAR files.

To deploy Unica Campaign, follow the guidelines in this section and then start the Unica Campaign server.

When you ran the Unica Campaign installer, you may have included Unica Campaign in an EAR file, or you may choose to deploy the Campaign WAR file. If you included the Unica Platform or other products in an EAR file, you must follow all the deployment guidelines detailed in the individual install guides for the products included in the EAR file.

You must know how to work with your web application server. Consult your web application server documentation for details such as navigation in the Administration console.



Note: Information about using web application clustering in Unica Campaign is provided in [Unica Campaign web application clustering on page 87](#).

Setting the web application session timeout

Session timeout determines how long an inactive HTTP session can remain open before the session expires. If required, you can set the web application session timeout for Unica Campaign by using the WebSphere® console or the WebLogic console to adjust the value of session timeout in seconds or minutes.

Set the session timeout on your web application server:

- WebSphere®: Use the WebSphere® Application Server Administrative Console to set the Session timeout in minutes. You can adjust this setting at the server and Enterprise Application levels. See your WebSphere® documentation for details.
- WebLogic: Use the WebLogic console to set the Session Timeout in seconds or adjust the **TimeoutSecs** parameter value for the **session-descriptor** element in the weblogic.xml file.

Deploying Unica Campaign on WebSphere Application Server

You can deploy the product runtime environment on supported versions of WebSphere® Application Server (WAS) from a WAR file or EAR file. The design time environment is deployed automatically with the product EAR or WAR file.

About this task

- Ensure that multiple language encoding is enabled in WAS.
- When you run the Install New Application wizard, ensure that you set the JDK Source Level to 18.
- Ensure that you add `javax.el-3.0.1-b11.jar` in WAS server lib directory. You can download `javax.el-3.0.1-b11.jar` from <https://mvnrepository.com/artifact/org.glassfish/javax.el/3.0.1-b11>
- Add JVM argument `-Dhttps.protocols=TLSv1.2` in Websphere for Unica Deliver to work.

- `-Dcollaborate.https.port=<https port configured for collaborate>`



Note: This system property is required only if Campaign communicates with Collaborate using https protocol.

Deploying Campaign on WAS from a WAR file

You can deploy the product application from a WAR file on WAS.

Before you begin

Complete the following tasks before you deploy the product:

- Confirm that your version of WebSphere meets the requirements in the Recommended Software Environments and Minimum System Requirements document, including any necessary fix packs or upgrades.
- Confirm that you created the data sources and database provider in WebSphere.

1. Go to the WebSphere® Integrated Solutions Console.
2. Go to **Applications > Application Types > WebSphere enterprise applications** and click **Install**.
3. In the **Preparing for the application installation** window, select the **Detailed - Show all options and parameters** check box and click **Next**.
4. Click **Continue** to see the **Install New Application** wizard.
5. Accept the default settings on the windows of the **Install New Application** wizard except the following windows:
 - In step 1 of the **Install New Application** wizard, select the **Precompile JavaServer Pages files** check box.
 - In step 3 of the installation wizard, set the **JDK Source Level** to 18.
 - In step 9 of the installation wizard, set the **Context Root** to `/Campaign`.
6. In the left navigation panel of WebSphere® Integrated Solutions Console, navigate to **Applications > Application Types > WebSphere enterprise applications**.
7. In the **Enterprise Applications** window, click the `Campaign.war` file.
8. In the **Web Module Properties** section, click **Session Management** and select the following check boxes.
Choose from:
 - Override session management
 - Enable CookiesClick **Enable Cookies**, and in the **Cookie name** field, enter a unique cookie name.
9. In the **Applications > Enterprise Applications** section of the server, select the WAR file that you deployed.
10. In the **Detail Properties** section, select **Class loading and update detection**.
11. In the **Class loader order** section, select the **Classes loaded with local class loader first (parent last)** option. In the **WAR class loader policy** section, select the **Single class loader for application** option.
12. Enter the context root for the application as `/Campaign`.
13. Go to **Application Servers > your server > Process definition > Java Virtual Machine**.
14. Users can add the following JVM arguments to enable unicode support with this JVM.
 - `-Dfile.encoding=UTF-8`
 - `-Dclient.encoding.override=UTF-8`

- `-Dcollaborate.https.port=<https port configured for collaborate>`



Note: This system property is required only if Campaign communicates with Collaborate using https protocol.

15. Start your deployment.

Deploying Campaign on WAS from an EAR file

You can deploy the product by using an EAR file if you included Campaign.

Before you begin

- Confirm that your version of WebSphere® meets the requirements in the *Recommended Software Environments and Minimum System Requirements* document, including any necessary fix packs or upgrades.
 - Confirm that you created the data sources and database provider in WebSphere®.
1. Go to the WebSphere® Integrated Solutions Console.
 2. Go to **Applications > Application Types > WebSphere enterprise applications** and click **Install**.
 3. In the **Preparing for the application installation** window, select the **Detailed - Show all options and parameters** check box and click **Next**.
 4. Click **Continue** to see the **Install New Application** wizard.
 5. Accept the default settings on the windows of the Install New Application wizard except the following windows:
 - In step 1 of the **Install New Application** wizard, select the **Precompile JavaServer Pages files** check box.
 - In step 3 of the installation wizard, set the **JDK Source Level** to 18.
 - In step 9 of the installation wizard, set the **Context Root** to /Campaign.
 6. In the left navigation panel of WebSphere® Integrated Solutions Console, navigate to **Applications > Application Types > WebSphere enterprise applications**.
 7. In the Enterprise Applications window, select the EAR file that you want to deploy.
 8. In the **Web Module Properties** section, click **Session Management** and select the following check boxes:
 - **Override session management**
 - **Enable Cookies**
 9. Click **Enable Cookies**, and in the **Cookie name** field, enter a unique cookie name.
 10. Select **Servers > WebSphere application server > server 1 > Session management > Enable Cookies** and clear the check box for **Set session cookies to HTTPOnly to help prevent cross-site scripting attacks**.
 11. In the **Detail Properties** section, select **Class loading and update detection**.
 12. In the **Class loader order** section, select the **Classes loaded with parent class loader first** option.
 13. In `campaign.ear`, open the **Manage Modules** section and select the **Classes loaded with local class loader first (parent last)** option.
 14. For **WAR class loader policy**, select the **Class loader for each WAR file in application** option.
 15. Go to **Application Servers > your server > Process definition > Java Virtual Machine**.
 16. Users can add the following JVM arguments to enable unicode support with this JVM.

- `-Dfile.encoding=UTF-8`
- `-Dclient.encoding.override=UTF-8`

- `-Dcollaborate.https.port=<https port configured for collaborate>`



Note: This system property is required only if Campaign communicates with Collaborate using https protocol.

17. Start your deployment.



Note: For Unica Campaign Websphere on HTTP and Unica Link (for native installation) on HTTPS, user need to set below parameters in Websphere JVM, SSL configuration and retrieve SSL certificates. To avoid problem "javax.net.ssl.SSLException: Received fatal alert: protocol_version"

JVM Arguments: `-Dhttps.protocols=TLSv1.2 -Djdk.tls.client.protocols=TLSv1.2`

**

Set the protocol to TLSv1.2 from WAS admin console in below mentioned path and restart your Websphere Application Server.

SSL Certificate and Key management -> SSL configurations ->NodeDefaultSSLSetings ->Quality of protection(Qop) settings

protocol: TLSv1.2

Retrieve the signer certificates from hip-rest server and add into NodeDefaultKeyStore and NodeDefaultTrustStore

*path: SSL certificate and key management > Key stores and certificates > NodeDefaultKeyStore > Signer certificates > Retrieve from port*

Deploying Unica Campaign on WebLogic

You can deploy Unica products on WebLogic. If a console is not accessible or does not exist, you can emulate a console using VNC or Exceed kind of applications. Contact your technical administrator to enable GUI mode display on Linux environments.

About this task

Use the following guidelines when you deploy Unica Campaign on WebLogic:

- Unica products customize the JVM used by WebLogic. You might need to create a WebLogic instance that is dedicated to Unica products if you encounter JVM-related errors.
- Verify that the SDK selected for the WebLogic domain you are using is the Sun SDK by looking in the startup script (`startWebLogic.cmd`) for the `JAVA_VENDOR` variable. It should be set to: `JAVA_VENDOR=Sun`. If it is set to `JAVA_VENDOR=BEA`, JRockit has been selected. JRockit is not supported. To change the selected SDK, refer to the WebLogic documentation.
- Deploy the Unica products as web application modules.
- On UNIX™ systems, you must start WebLogic from the console to allow correct rendering of graphical charts. The console is usually the machine on which the server is running. However, in some cases the web application server is set up differently.

Connecting to the UNIX™ machine via telnet or SSH always causes problems rendering charts.

- If you are configuring WebLogic to use the IIS plug-in, review the WebLogic documentation.
- Add the following parameters in the `JAVA_OPTIONS` section of `startWeblogic.cmd` OR `startWeblogic.sh`:

```
-Dfile.encoding=UTF-8
```

- Add the following parameters if you require to enable unicode support with Unica Campaign environment.

```
-Dfile.encoding=UTF-8
```

```
-Dclient.encoding.override=UTF-8
```

```
-Dcollaborate.https.port=<https port configured for collaborate>
```

- If you are deploying in a production environment, set the JVM memory heap size parameters to at least 1024 by adding the following line to the `setDomainEnv` script:

```
Set MEM_ARGS=-Xms1024m -Xmx1024m -XX:MaxPermSize=256m
```

- Under certain circumstances, deploying older legacy interactive channels or interactive channels with large deployment histories can stress the system and require 2048mb or greater of Unica Campaign designtime and/or Interact runtime Java™ heap space.

System administrators can adjust the amount of memory available to the deployment systems via the following JVM parameters:

```
-Xms####m -Xmx####m -XX:MaxPermSize=256m
```

Where the characters `####` should be 2048 or higher (depending on their system load.) Note that a 64-bit application server and JVM are usually necessary for values greater than 2048.

These are the suggested minimum values. Analyze your sizing requirements to determine correct values for your needs.

Additional configuration required for SSL environments

From the 12.0 release onwards, SSL for C++ components in Unica products is supported by OpenSSL.

If you have implemented SSL for C++ components (such as the Unica Campaign listener) in the 10.0.x to 11.1.x version of Unica products, you must do the following for these components.

- Create an openssl key file (.pem).
- Create new certificates using GSKit.
- Create new openssl certification key.
- Optionally create or get new certificate.
- Import openssl certification or key in certificate.
- Configure your environment to use the new certificates.

For details, see the *Unica Platform Administrator's Guide*, Chapter 14: Implementation of one-way SSL.

Configuring WebLogic to display reports (UNIX)

If you install Unica Campaign with Unica Optimize on a UNIX™ system, you must enable the `java.awt.headless` JVM property so that the WebLogic web application server can display the graphs in Unica Optimize reports.

About this task

To enable graph display in Optimize reports in the Weblogic JVM:

1. Shut down the Weblogic server if it is already running.
2. Locate and open the startup script for your Weblogic server (`startWebLogic.sh`) in any text editor.
3. Modify the `JAVA_OPTIONS` parameter to add the following value:

```
-Djava.awt.headless=true
```

4. Save the startup script, then restart the Weblogic server.

Deploying Unica Campaign on Tomcat Application Server

Use the following guidelines when you deploy Unica Campaign on Tomcat:

- HCL Unica products customize the JVM used by Tomcat. You may require to create a Tomcat instance that is dedicated to HCL Unica products if you encounter JVM-related errors
- If you are deploying in a production environment, set the JVM memory heap size parameters to at least 1024 by adding the following line to the `setenv.bat/sh` e.g : `set CATALINA_OPTS=%CATALINA_OPTS% -Xms1024m -Xmx1024m`

```
-XX:MaxPermSize=512m.
```

These are the suggested minimum values. Analyze your sizing requirements to determine correct values for your needs. Depending upon system load **-Xmx** value should be adjusted. Note that a 64-bit application server and JVM are usually necessary for values greater than 2048.

- Modify the `JAVA_OPTIONS` parameter to add the following value in `setenv.bat/sh`.

```
set JAVA_OPTS=%JAVA_OPTS% -DUNICA_PLATFORM_CACHE_ENABLED=true -Dclient.encoding.override=UTF-8.
```

- When Unica Insights war is deployed on Tomcat, complete the following configuration in `server.xml`, where `Campaign.war` is deployed.

Add `relaxedQueryChars` under `Campaign server.xml` as mentioned below.

```
<Connector port="8080" protocol="HTTP/1.1"
connectionTimeout="20000"
redirectPort="8443"
relaxedQueryChars="|, [, ], \, ` , { , } , ^" />
```

- You must add Unica Platform and Unica Campaign data source in `Campaign.xml` along with the path of `Campaign.war` to the Unica Campaign Tomcat instance. For example:

```
<Context docBase="<Campaign_Install_Path>/Campaign/Campaign.war">
<Resource name="<UnicaPlatformDS>" factory="com.unica.manager.tomcat.utils.TomcatDSFactory"
auth="Application" type="javax.sql.DataSource"
maxActive="30" maxIdle="10" maxWait="10000"
username="<db user for Platform schema>" password="<db password>" driverClassName=
"<db specific class name>" url="<db specific jdbc url>" />
```

```
<Resource name="<campaignPartitionIDS>" factory="com.unica.manager.tomcat.utils.TomcatDSFactory"
  auth="Application" type="javax.sql.DataSource"
  maxActive="30" maxIdle="10" maxWait="10000"
  username="<db user for Campaign schema>" password="<db password>" driverClassName=
  "<db specific class name>" url="<db specific jdbc url> </Context>" />
```

This parameter is to increase the size of the HTTP request to avoid campaign flowchart crashes that exceed the default size supported by Tomcat.

Please include below parameters in the <TOMCAT_HOME>/<Campaign_Instance>/conf/server.xml file.

- maxHttpHeaderSize="209715200"
- maxPostSize="-1"

Starting the Unica Campaign server

Make sure that Unica Platform and Unica Campaign web applications are deployed and running when you start the Unica Campaign server.

About this task

You can start the Unica Campaign server directly or install it as a service.

Starting the Unica Campaign listener manually

Start the Unica Campaign listener by running the `cmpServer.bat` file for Windows™, or the `rc.unica_ac` command for UNIX™.

About this task

Follow the instructions appropriate for your operating system.

Windows™

Start the Unica Campaign listener by running the `cmpServer.bat` file in the `bin` directory under your Unica Campaign installation. When the `unica_aclsnr.exe` process appears on the Windows™ Task Manager Processes tab, the server has started successfully.

UNIX™

Start the Unica Campaign listener by executing the `rc.unica_ac` program with a `start` argument. You must run this command as root. For example:

```
./rc.unica_ac start
```

To determine whether the `unica_aclsnr` process has started successfully, enter this command:

```
ps -ef | grep unica_aclsnr
```

To determine the process ID for the server you started, view the `unica_aclsnr.pid` file located in the `conf` directory under your Unica Campaign installation.



Note: Since Unica Campaign supports listener clustering, a loop is added in the `rc.unica_ac` which automatically restarts the listener if in case the listener goes down or crashes. Also, process `rc.unica_ac` still remains after starting listener and the parent process may change. For example, if you are upgrading from Release 8.6.0.4 to Release 9.1.1, the parent process of `unica_aclsnr` can be changed to `rc.unica_ac` instead of `init`, which was the former parent process and the process `rc.unica_ac` still remains after starting the listener.

Installing the Unica Campaign listener as a Windows service

You can install the Unica Campaign listener as a Windows™ service so that it starts automatically whenever you start Windows™.

1. Add the `bin` directory under the Unica Campaign installation directory to the user `PATH` environment variable. If the `PATH` environment variable does not exist for the user, create it.

Make sure that you add this path to the user `PATH` variable, not the system `PATH` variable.

If the Unica Campaign `bin` directory exists in the system `PATH` environment variable, remove it. You do not need it in the system `PATH` environment variable to install the Unica Campaign listener as a service.

2. If you are upgrading from a previous version of Unica Campaign that had the server installed as a service, stop the service.
3. Open a command window and change directories to the `bin` directory under your Unica Campaign installation.
4. Run the following command to install the Unica Campaign listener as a Windows™ service:

```
unica_aclsnr -a
```



Note: The `-a` option includes auto-restart functionality. If you do not want the service to attempt to restart automatically, use `unica_aclsnr -i`.

Result

The listener is now installed as a service.



Note: Make sure `CAMPAIGN_HOME` has been created as a system environment variable before starting the Unica Campaign listener service.



Note: You must add the appropriate listener type.

5. Open the **Unica Campaign Listener Service** properties dialog box. Click the **Log On** tab.
6. Select **This account**.
7. Enter the user name (system user) and password and start the services.

Chapter 6. Configuring Unica Campaign and Unica Optimize after deployment

After you deploy Unica Campaign, you must verify that the Unica Campaign listener is running, set up the Unica Campaign system user, set Unica Campaign configuration properties, and verify the Unica Campaign installation.

If you are using the Unica reporting feature, you must complete the tasks that are described in the *Unica Reports Installation and Configuration Guide*.



Note: If you plan to enable Unica Deliver for hosted email, you must use the Unica reporting feature to view standard Unica Deliver performance reports.

Google Chrome and Microsoft Edge configuration

Recently, the browsers Google Chrome and Microsoft Edge updated a security fix and this security fix affects the access of Unica applications. We have received some issues from our customers like:

- issues with UI
- unable to edit flowcharts
- getting logged out from Unica

These issues are observed due to the change of behavior in browsers after applying the security fix. Applying the security fix automatically enables **Origin-keyed Agent Clusters by default**. If the setting **Origin-keyed Agent Clusters by default** is enabled automatically, it prevents changes in document referrer and domain values so that malicious websites cannot execute any type of impersonation. The setting **Origin-keyed Agent Clusters by default** existed earlier as well, but was not enabled by default.

If you update Google Chrome or Microsoft Edge to the latest version, you will observe the earlier mentioned issues. Because of how Unica is designed and because the Unica suite is deployed over multiple JVMs, it is essential that you disable the **Origin-keyed Agent Clusters by default** setting for Unica to function correctly and to provide a good user experience.

As a solution, we recommend that you perform the steps mentioned in the following Knowledge Base article: https://support.hcltechsw.com/csm?id=kb_article&sysparm_article=KB0107185.



Note: The update to Microsoft Edge browser is very recent and the Knowledge Base article is not yet updated for the Microsoft Edge browser.

The CliffsNotes solution is as follows:

1. Open your browser and navigate to one of the following URLs based on your browser:
 - **Google Chrome:** <chrome://flags/#origin-agent-cluster-default>
 - **Microsoft Edge:** <edge://flags/#origin-agent-cluster-default>
2. From the dropdown of the highlighted parameter **Origin-keyed Agent Clusters by default**, select `Disabled`.

3. At the bottom of the page, click the **Apply Changes** button.
4. Log out of Unica applications, log back in, and verify if everything is working as expected.

Setting the Unica Optimize configuration properties manually

Set configuration properties for the Unica Optimize listener. You can set the host server name and port for the Unica Optimize. You can configure Unica Optimize to connect to the Unica Platform server by using SSL as well.

About this task

If the Unica Campaign installer cannot access the Unica Platform system tables during the installation process, the installer displays an error message. The installation process proceeds, but go to **Settings > Configuration** to set the Unica Optimize configuration properties manually.

If required, set the following Unica Optimize configuration properties under the **Campaign > unicaACOListener** category manually:

- **serverHost**
- **serverPort**
- **useSSL**



Note: If you have a single listener (Non-Cluster) then

- If the listener is FOR Campaign flowcharts only, then configure the configuration properties under Campaign > unicaACLlistener >
- If the listener is FOR Optimize sessions only, then configure the configuration properties under Campaign > unicaACOListener >
- If the listener is FOR BOTH Campaign flowcharts and Optimize sessions, then configure the both configuration properties under Campaign > unicaACLlistener >
Campaign > unicaACOListener >

Following properties under unicaACLlistener and unicaACOListener, should have same values , since there is only one listener serving Campaign and Optimize both.

- serverHost
- serverPort
- useSSL



Note: If you have a clustered listener then listener configuration is defined as usual, under following configuration property Campaign > unicaACLlistener > listenerNode .



There is one additional configuration parameter as "listenerType" which defines whether the listener is for Campaign or Optimize or BOTH.

ListenerType - 1 - Run only Campaign flowcharts

ListenerType - 2 - Run only Optimize sessions

ListenerType - 3 - Run Campaign flowchart and Optimize session

And additional properties present under Campaign > unicaACLlistener are applicable for the listener.

Verifying that the Unica Campaign listener is running

The Unica Campaign listener must be running before users can work with any Unica Campaign features. The listener automatically creates a separate `unica_acsvr` process for each login and each active flowchart. For example, if one user logs in and then opens a flowchart, the listener creates two instances of `unica_acsvr.exe`.

About this task

Use the following procedure to verify that the Unica Campaign listener is running.

1. Use the appropriate procedure for your operating system:

In Windows™, look for `unica_aclsnr.exe` on the **Processes** tab of the Windows™ Task Manager.

In UNIX™, use the `ps` command to look for the Unica Campaign server, as in the following example: `ps -ef | grep unica_aclsnr`.

2. If the listener is not running, restart it:

In Windows™, run the `cmpServer.bat` script that is in the `bin` directory under your Unica Campaign installation.

In UNIX™, enter the following command at the system prompt: `rc.unica_ac start`

For important details about running the listener, including how to start it automatically, see the *Unica Campaign Administrator's Guide*.

Setting up the Unica Campaign system user

Set up the Unica Campaign system user to directly access databases. For multiple partitions in Unica Campaign, create a system user for each partition.

A system user is a Unica user account that is configured for use by applications.

To avoid presenting users with repeated prompts for login credentials you can associate a system user with one or more data sources. Each data source specifies a user name and password. This allows you to provide a user name and password to access a database or other protected resource by referencing the data source. By adding multiple data sources to the configuration of the system user account, you can allow the system user to access multiple databases.

In Unica Campaign, the system user holds login credentials for accessing system tables and other data sources.

Use an existing or new Unica user account to save credentials for the data sources described here.

You set up Unica users and assign user data sources in the **Settings > Users** area of Unica. See the online help in that section for instructions on how to do this.

Set up a user account to hold credentials for the following data sources.

- Unica Campaign system tables (UA_SYSTEM_TABLES)
- All customer (user) tables

On UNIX™, for the **Alternate Login** attribute of the system user, enter the UNIX™ account of a user in a group that shares privileges with the UNIX™ users of Unica Campaign.



Note: If you have multiple partitions, each partition must have its own system user. The system user cannot be the same across partitions.

Adding data source properties on the **Configuration** page

Use the appropriate data source template to add data source properties on the **Configuration** page for each Unica Campaign data source.

About this task

The Unica Campaign installer imports the template for the database type that you specified for the Unica Platform database when you ran the installer.

If you need other data source templates for additional database types, you must import them manually using the Unica Platform `configTool` utility. You can import as many templates as you need, to correspond to each different type of database you have.

For example, suppose your installation of Unica Platform and Unica Campaign used the following databases:

- Oracle - system tables
- DB2® - customer (user) tables
- DB2® - additional customer (user) tables

In this case, you would import the `DB2Template.xml` template for the two sets of customer (user) tables.

If your Unica Platform and Unica Campaign system tables databases are of the same database type, the installer automatically imports the template that is used for the system tables; in this example, it imports the Oracle template.

For instructions, see [Importing data source templates on page 43](#).

You create a new category from the template, which creates a new set of data source configuration properties. Create as many new categories as needed, one for each data source of that type. In the example above, you would use the Oracle template to create one new category and the DB2® template to create two new categories. See [Duplicating a data source template on page 43](#).

After you add the data source properties, set the data source configuration properties in the categories you created from the templates.

For instructions, see [Data source properties on page 44](#).

Importing data source templates

The Unica Campaign system tables data source (UA_SYSTEM_TABLES) is supported only on Oracle, DB2®, and SQLServer. Import the data source templates for the user tables by using the configTool utility to support the database types that are not supported for the Unica Campaign system tables.

About this task

The Unica Campaign data source templates are located in the `conf` directory under your Unica Campaign installation.

To import and export templates, you use the Unica Platform `configTool` utility, located in the `tools/bin` directory under your Unica Platform installation. If you are not familiar with `configTool`, see [configTool on page 69](#) for details on performing this task.

Here is an example of the command you would use to import the Oracle template into the default partition (Windows™ environment).

```
configTool -i -p "Campaign|partitions|partition1|dataSources" -f full_path_to_directory_containing_your_Oracle_template
\OracleTemplate.xml
```

Duplicating a data source template

Duplicate the data source templates to create a new set of configuration properties in the data source category.

1. On the Configuration page, navigate to the data source template you want to duplicate.

Unlike other categories, template category labels are in italics and enclosed in parentheses.

2. Click the data source template.

Result

The Create category from Template page displays.

3. Enter a name in the **New category name** field (required).



Note: The data source category name for the Unica Campaign system tables **MUST** be `UA_SYSTEM_TABLES`.

4. If desired, edit properties within the new category. You can also do this later.
5. Click **Save and Finish**.

Results

The new category appears in the navigation tree.

Unica Campaign configuration properties

You must specify configuration properties on the **Configuration** page for a basic installation of Unica Campaign. Additionally, you can use the **Configuration** page to specify the properties that perform important functions that you can optionally adjust.

Data source properties

The following table provides information about the properties that you must specify for each Unica Campaign data source:

Table 7. Properties for each Unica Campaign data source

| Property name | Description |
|--------------------------------------|---|
| <code>ASMUserForDBCredentials</code> | This property must be the same user you already created as the Unica Campaign system user in Setting up the Unica Campaign system user on page 41 . |
| <code>DSN</code> | For SQL server, set this property to the DSN (data source name) you created. For Oracle and DB2®, set this property to the database name or the SID (service) name. |
| <code>JndiName</code> | Set this property to the JNDI you created in your application server to connect to this specific data source. For Tomcat, JNDI name should be prefixed with "java:/comp/env/" for example: campaignPartition1DS should be mentioned as java:/comp/env/campaignPartition1DS |
| <code>SystemTableSchema</code> | Not required for SQL server. For other data sources, set this property to the user of the database to which you are trying to connect. |
| <code>OwnerForTableDisplay</code> | Not required for SQL server. For other data sources, set this property to the user of the database to which you are trying to connect. |

The data sources are the Unica Campaign system table database and any customer (user) databases you plan to use with Unica Campaign.



Note: The data source category name for the Unica Campaign system tables **must** be `UA_SYSTEM_TABLES`.

For details on setting the values, see the context help for these properties or the *Unica Platform Administrator's Guide*.

In addition to creating and setting data source properties, you must set the following properties on the **Configuration** page for a basic installation of Unica Campaign.

- Campaign > unicaACOListener > serverHost
- Campaign > unicaACOListener > serverPort
- Campaign > unicaACLlistener > serverHost
- Campaign > unicaACLlistener > serverPort

For single-node Campaign environment, where the same listener is serving both Campaign flowchart execution and Optimize session execution, `unicaACOListener > serverPort` must have the same value as `unicaACLlistener > serverPort`

- For the default partition, set values as required in the categories under Campaign > partitions > partition1.

When you change a property, you must restart the Unica Campaign listener for the changes to take affect.

Mapping user tables in Unica Campaign

Mapping user tables is the process of making external data sources accessible in Unica Campaign. A typical user table contains information about your company's customers, prospects, or products. The data source can be a database table or ASCII flat file. You must map any data sources that you configured to make that data accessible to processes in flowcharts.

About this task

For instructions on how to map user tables, see the *Unica Campaign Administrator's Guide*.



Note: User tables are different from system tables. Most Unica Campaign system tables are mapped automatically during initial installation and configuration if you use the system table data source name UA_SYSTEM_TABLES. If a connection issue forces you to map system tables manually, you must log out of Unica Campaign and log in again after you map the tables.

Mapping tables for Unica Optimize

You can exchange data between Unica Optimize and Unica Campaign by mapping the Unica Optimize system tables, contact history tables, and segment membership tables to the Unica Campaign tables.

About this task



Note: Mapping the segment membership system tables in Unica Campaign for use with strategic segments is optional. Map the segment membership system table for an audience only if you use the audience with flowcharts or Unica Optimize sessions that use strategic segments.

For more information about mapping system tables in Unica Campaign, see the *Unica Campaign Administrator's Guide*.

Complete the following steps to map tables for Unica Optimize:

1. Map all system tables.
2. Map all contact history tables.

Confirm that each audience level in your Unica Campaign configuration has a contact history table. You must map each contact history table. For more information about additional contact history tables, see the *Unica Campaign Administrator's Guide*.

3. **Optional:** For each audience used in Unica Optimize sessions that use strategic segments, map the segment membership system table for the audience to the database table that defines the segment members.

Requirements when you use strategic segments:

If you plan to use strategic segments, ensure that there is a segment membership table for each audience level in your Unica Campaign configuration. You must map each segment membership table.

Create two indexes on the audience segment membership tables. Create the first index on SegmentID and create the second on the audience level columns. The `UA_SegMembership` table ships with an index on CustomerID and on SegmentID.

For more information about system tables and strategic segments, see the *Unica Campaign Administrator's Guide*.

Unica Optimize system table mapping reference

To integrate Unica Optimize with Unica Campaign, map all the Unica Optimize system tables to the Unica Campaign tables.

You can exchange data between Unica Optimize and Unica Campaign by mapping the Unica Optimize tables in Unica Campaign. Map all the Unica Optimize system tables, contact history tables, and segment membership tables to the Unica Campaign tables.

Use the following table to get information about the Unica Optimize system tables and the corresponding database tables:

Table 8. Unica Optimize system table mapping

| Unica Optimize System Table | Database Table |
|---|----------------------|
| Optimize Session Table | UACO_OptSession |
| Optimize Process Table | UACO_OptimizeProcess |
| Optimize Run History Table | UACO_SesnRunHist |
| Optimize Session Segment Table | UACO_SesnSegment |
| Optimize Offer Segment Table | UACO_OfferSeg |
| Optimize Session Offer Table | UACO_SesnOffer |
| Optimize Rule Table | UACO_Rule |
| Optimize Exception Rule Table | UACO_RException |
| Optimize Exception Rules Constraint Table | UACO_RExConstraint |
| Optimize Rules Constraint Table | UACO_RConstraint |
| Optimize Rule OfferList Table | UACO_ROfferList |
| Optimize Rule Offer Table | UACO_ROffer |
| Optimize Rule Segment Table | UACO_RSegment |
| Optimize Proposed Contact Base Table | UACO_PCTBase |
| Optimize Proposed Attribute Base Table | UACO_POABase |
| Optimize Optimized Contact Base Table | UACO_OCTBase |

Unica Optimize contact history table mapping reference

To integrate Unica Optimize with Unica Campaign, map all the Unica Optimize contact history tables to the Unica Campaign tables.

Use the following table to get information about the Unica Optimize contact history tables and the corresponding database tables:

Table 9. Unica Optimize contact history table mapping

| Contact History Table | Database Table |
|---|-------------------|
| Customer Contact History Table | UA_ContactHistory |
| Customer Detailed Contact History Table | UA_DtlContactHist |

The names of additional audience level tables are unique according to your configuration of Unica Optimize.

Verifying the Unica Campaign installation

If you performed all of the steps to install and configure Unica Campaign, deploy the Unica Campaign web application, and configure Unica Campaign after deployment, you are ready to verify your installation.

Before you begin

If you have not already done so, log in to Unica as a user that exists in the Unica Campaign Administrators role (such as asm_admin). In **Settings > Users**, assign at least one security role (for example, Global Policy/Admin) to the new user. After the new user is assigned the role, you can log in to Unica Campaign as that new user.

About this task

Use the following procedure to verify the installation.

1. Log in to Unica.
2. Verify that all system tables exist in the **Settings > Campaign Settings > Manage Table Mappings** window.
3. Create a campaign and create a flowchart in that campaign.

Verifying the Unica Optimize installation

If Unica Optimize is installed correctly, you must be able to use the Optimize process in Unica Campaign when you build the Unica Campaign batch flowcharts. To verify, log in to Unica and confirm that you can access **Campaign > Optimizes**.

Before you begin



Note: Before you verify that Unica Optimize is installed or upgraded correctly, make sure that the **Affinium|Campaign|acoInstalled** property is set to true. If the **Affinium|Campaign|acoInstalled** is set to false, you get an error message that indicates Unica Optimize is not installed.

About this task

After you map the Unica Optimize tables to the Unica Campaign tables, you might have to log out and log in to the Unica console to show **Campaign > Optimize sessions**.

Complete the following steps to verify the Unica Optimize installation:

1. Log in to the Unica console.
2. Select **Campaign > Optimizes** from the menu.

Result

The **All Optimize sessions** page is displayed. Verify that you can view and manage your Unica Optimize sessions.

Ensuring that your flowcharts are searchable

If you upgrade to Unica Campaign version 11.1 from any release prior to version 10.1, you must ensure that your flowcharts are searchable.

About this task

You can use the `adv_SrchUtil` utility to perform this task. The `adv_SrchUtil` utility is a wrapper script that creates or repairs flowchart `.ses` file search indexes on all campaign and session flowcharts in the specified partition.

See the *Unica Campaign Administrator's Guide* for details on using this utility.

Setting properties for integration with Unica products

Unica Campaign integrates with various applications. If required, you can specify configuration properties to set up an integration between Unica Campaign and other products.

Additional configuration for enhanced security

The procedures in this section describe some additional configurations in the web application server. They are optional, but you might want to perform them for enhanced security.

Disabling the X-Powered-By flag

If your organization is concerned that the X-Powered-By flag in the header variable is a security risk, you can disable it using this procedure.

1. If you are using WebLogic, in the administration console, under **domainName > Configuration > Web Application**, set **X-Powered-By Header to X-Powered-By Header will not be sent**.
2. If you are using WebSphere®, perform the following steps.

- a. In the WebSphere® administration console, navigate to **Servers > Server Types > WebSphere application servers > server_name > Web Container Settings > Web container**.
- b. Under **Additional Properties** select **Custom Properties**.
- c. On the Custom Properties page, click **New**.
- d. On the Settings page, create a custom property named `com.ibm.ws.webcontainer.disablePoweredBy` and set the value to `false`.
- e. Click **Apply** or **OK**.
- f. Click **Save** on the console task bar to save your configuration changes.
- g. Restart the server.

Configuring a restrictive cookie path

In your web application server, you can restrict cookie access to a specific application for enhanced security. If not restricted, cookies are valid across all the deployed applications.

1. If you are using WebLogic, perform the following steps.
 - a. Extract the `weblogic.xml` file from the WAR or EAR package where you want to add the restrictive cookie path.
 - b. Add the following to the `weblogic.xml` file, where `context-path` is the context path for the deployed application. For Unica applications the context path is typically `/unica`.

```
<session-descriptor>
  <session-param>
    <param-name>CookiePath</param-name>
    <param-value>/context-path</param-value>
  </session-param>
</session-descriptor>
```

- c. Rebuild the WAR or EAR file.
2. If you are using WebSphere®, perform the following steps.
 - a. In the WebSphere® administration console, navigate to the **Session Manager > Cookie** tab.
 - b. Set the **Cookie Path** to the context path of your application.
For Unica applications the context path is typically `/unica`.

Starting the Unica Campaign Advance search agent

You can use the Unica Campaign Advance search agent to search for flowcharts that you have created in Unica Campaign. You can search for flowcharts only if the Advanced search agent is running when the a flowchart is created or modified.

Before you begin

Unica Platform and Unica Campaign web applications must be deployed and running before you start the Unica Campaign Advance search agent.

To start the Unica Campaign Advance search agent manually, complete the following steps:

1. For Windows, go to the bin directory under your Unica Campaign installation and run `advSrchAgent.bat`.

Result

The `advSrchAgent.bat` file keeps running at the prompt.

2. For Unix, go to the bin directory under your Unica Campaign installation and run `advSrchAgent.sh`.

Result

The `advSrchAgent.sh` file keeps running at the prompt.

Example

For a Unix operating system, run the following command to start the Unica Campaign Advance search agent.

```
./advSrchAgent.sh partition1
Usage:
./advSrchAgent.sh <start | stop> <partition_name> [cluster_home] [-u <user_name>] [-p <password>]
Where:
<start | stop> : Start or stop the agent.
<partition_name> : Name of the partition from which flowchart files are to be exported.
[cluster_home] : Home directory of clustered environment, if clustering is enabled.
[-u <user_name>] : User name for user who has read access to all flowchart files in the partition specified.
[-p <password>] : Password of the user specified
```

Chapter 7. Configuring multiple partitions for Unica Campaign

In the Unica family of products, partitions provide a way to secure the data that is associated with different groups of users. When you configure Unica Campaign or a related Unica application to operate with multiple partitions, users can see each partition as a separate instance of the application. There is no indication that other partitions exist on the same computer.

How multiple partitions work

For the Unica applications that operate with Unica Campaign, you can configure the application within the partitions where you have configured an instance of Unica Campaign. Application users within each partition can access the Unica Campaign functions, data, and customer tables that are configured for Unica Campaign in the same partition.

Partition benefits

Multiple partitions are useful for setting up strong security between groups of users, because each partition has its own set of Unica Campaign system tables. Multiple partitions cannot be used when groups of users must share data.

Each partition has its own set of configuration settings, and Unica Campaign can be customized for each group of users. However, all partitions share the same installation binaries. With the same binaries for all partitions, you can minimize the installation and upgrade efforts for multiple partitions.

Partition user assignment

Access to partitions is managed through membership in Unica Platform groups.

Except for the partition superuser (platform_admin), each HCL user can belong to one partition. A user who requires access to multiple partitions must have a separate user account for each partition.

If there is only one partition, users do not have to be explicitly assigned to that partition to have access to Unica Campaign.

Partition data access

In a multi-partition configuration, partitions have the following security characteristics:

- A user cannot access a partition if the user is not a member of a group that is assigned to a partition.
- A user of one partition cannot view or change data in another partition.
- Users cannot navigate the Unica Campaign file system above the root directory of their partition from the browse dialog boxes in Unica Campaign. For example, if two partitions, named partition1 and partition2 exist, and you belong to the group that is associated with partition1, you cannot navigate the directory structure for partition2 from a dialog box.

Setting up multiple partitions

Configure multiple partitions in Unica Campaign to isolate and secure data for different groups of Unica Campaign users. As each partition has its own set of configuration properties, you can customize Unica Campaign for each group of users.

Before you begin

Before you configure additional partitions in Unica Campaign, complete the following tasks for each partition that you are configuring:

1. Create database or schema for the Unica Campaign system tables
2. Create ODBC or native connections
3. Create JDBC connections in the web application server

Complete the following tasks to set up multiple partitions for Campaign:

1. Create the system tables database and any other data sources required for your partitions. Then configure the JDBC and ODBC or native connections required to access your data sources.
2. For each partition, create a different schema in your database to hold the system tables. Use the database-specific scripts packaged with Campaign to create and populate the system tables.
3. Complete the following tasks to create a directory structure for each additional partition:



Note: Save a clean copy of the original `partition1` directory to serve as a backup.

- a. In the `partitions` directory under your Unica Campaign installation, create a duplicate of the default `partition1` directory for each partition that you are adding, ensuring that you include all sub-directories.
- b. Name each partition directory with a unique name. Use these exact same names for the partitions when you later create their configuration trees on the **Configurations** page.

Example

If you want to create a second partition and created the directory named `Campaign/partitions/partition2`, when you create the configuration tree on the **Configurations** page, you must use the name "partition2" to identify this partition.

- c. Delete any files that exist in the duplicate partition sub-directories.
4. Complete the following tasks to use the `partitionTool` utility with the `-s` option to clone the default partition:



Note: If you decide not to use this option, you must stop the web application server where Unica Platform is deployed before performing this procedure.

- a. Set the `JAVA_HOME` environment variable, either in the `setenv` script located in the `tools/bin` directory of your Unica Platform installation, or in the command line window in which you run the `partitionTool` utility.
- b. Open a command line window and run the utility from the `tools/bin` directory under your Unica Platform installation. Use the appropriate command and options (as described in the *Unica Platform Administrator's Guide*) to achieve your desired results.

Example

```
partitionTool -c -s partition1 -n partition2
```

- c. Repeat this procedure for each new partition you need to create.

- d. When you are finished, stop and restart the application server where Unica Platform is deployed to see the groups that were created.



Note: For complete information on using this utility, see [partitionTool on page 76](#).

5. Complete the following tasks to create the partition structure on the **Configuration** page by using the `New partitionTemplate` for each new partition:
 - a. On the **Configuration** page, navigate to **Campaign > partitions** and click `(partitionTemplate)`.

If you do not see the `(partitionTemplate)` property in the list, use the `configTool` utility to import the partition template, using a command similar to the following:

```
configTool -i -p "Affinium|Campaign|partitions"
-f <CAMPAIGN_HOME>/conf/partitionTemplate.xml
```

Replace `CAMPAIGN_HOME` with the actual path to your Unica Campaign installation.

The `configTool` utility is found in the `tools` directory under your Unica Platform installation. See the *Unica Platform Administrator's Guide* for information on using this utility.

Result

In the right pane, you see the partitionTemplate pane with an empty **New category name** field.

- b. Enter the name for the new partition, using the same name that you used when creating the partition's directory structure in the file system in [Setting up multiple partitions on page 51](#).
- c. Click **Save Changes**.

Result

You see the new partition structure, with the same categories and properties as in the partition template.



Note: If campaign is having multiple partitions, then during upgrade user need to upgrade all the partitions.

Partition superuser

To administer security across all users of Unica Platform, a user account must exist that has access to all security settings and user accounts in the system.

By default, this user account is `platform_admin`. This user account does not belong to any one partition; instead, it has access to all user accounts in all partitions.

The administrator can create additional users with the same level of access. To be a partition superuser, an account must have Admin access to the Unica Platform and have full access to the Users, User Groups, and User Permissions pages. The partition superuser does not require access to product-specific security pages, such as Unica Campaign security pages.

Configuring data source properties for partitions

You must configure data source properties for each partition that you create. Use the appropriate data source template to create data source properties.

About this task

The Unica Campaign installer imports the template for the database type that you specified for the Unica Platform database when you ran the installer.

If you need other data source templates for additional database types, you must import them manually using the Unica Platform configTool utility. You can import as many templates as you need to correspond to each different type of database you have.

For example, suppose your installation of Unica Platform and Unica Campaign used the following databases:

- Oracle - system tables
- DB2® - customer (user) tables
- DB2® - additional customer (user) tables

In this case, you would import the `DB2Template.xml` template for the two sets of customer (user) tables.

If your Unica Platform and Unica Campaign system tables databases are of the same database type, the installer automatically imports the template used for the system tables; in this example, it imports the Oracle template.



Note: When you create a new partition, you must use the configTool utility to import the data source templates for the system tables and user tables.

For instructions, see [Importing data source templates on page 43](#).

You create a new category from the template, which creates a new set of data source configuration properties. Create as many new categories as needed, one for each data source of that type. In the example above, you would use the Oracle template to create one new category and the DB2® template to create two new categories. See [Duplicating a data source template on page 43](#).

After you add the data source properties, set the data source configuration properties in the categories you created from the templates.

For instructions, see [Unica Campaign configuration properties on page 43](#).

Complete the following tasks to configure data source properties for each partition:

1. Add data source configuration properties to the **Configuration** page for each Unica Campaign data source by using the appropriate data source template.

The Unica Campaign installer imports the template for the database type that you specified for the Unica Platform database when you ran the installer. If you need other data source templates for additional database types, you must import them manually using the Unica Platform `configTool` utility. You can import as many templates as you need, to correspond to each different type of database you have.

Example

For example, suppose your installation of Unica Platform and Unica Campaign used the following databases:

- Oracle - system tables
- DB2® - customer (user) tables
- DB2® - additional customer (user) tables

In this case, you would import the `DB2Template.xml` template for the two sets of customer (user) tables.

Result

If your Unica Platform and Unica Campaign system tables databases are of the same database type, the installer automatically imports the template used for the system tables; in this example, it imports the Oracle template. For instructions, see [Importing data source templates on page 43](#).

2. Create a new category from the template, which creates a new set of data source configuration properties. Create as many new categories as needed, one for each data source of that type. In the example above, you would use the Oracle template to create one new category and the DB2® template to create two new categories. See [Duplicating a data source template on page 43](#).
3. Set the data source configuration properties for each Unica Campaign data source. See [Unica Campaign configuration properties on page 43](#) for more information.

Setting up system users for Unica Campaign

You can associate a system user with one or more Unica Platform data sources to avoid presenting users with repeated prompts for login credentials. Each data source specifies a user name and password. You can provide a user name and password to access a database or other protected resources by referencing the data source. By adding multiple data sources to the configuration of the system user account, you can allow the system user to access multiple databases.

About this task

Unica applications might require a system user account configured with the following attributes:

- Login credentials for accessing system tables or other data sources.
- Specific permissions to create, modify, and delete objects within the system.

For more information about setting up a new user and assigning a data source to a user, see the *Unica Platform Administrator's Guide*.

Complete the following actions to set up system users for Unica Campaign:

1. Use an existing or a new user account to save credentials for the following data sources:
 - Unica Campaign system tables
 - All customer (user) tables

2. On UNIX™, for the **Alternate Login** attribute of the system user, enter the UNIX™ name for a user in a group that shares privileges with the UNIX™ users of Unica Campaign.



Note: If you have multiple partitions, you must create a system user for each partition.

Using IBM Cognos Reports for multiple partitions

If you want to use IBM Cognos® Reports for multiple partitions in Unica Campaign, Unica Deliver, or Unica Interact, you must configure IBM Cognos® reports packages for each partition.

For instructions, see the *Unica Reports Installation and Configuration Guide*.

Assigning roles, permissions, and groups for partitions

Before you can use the partitions that you have configured for Unica Campaign, you must assign roles to the user with administrator role in each partition. You must also assign a group to each partition.

Use the partitionTool utility to create a default admin user for each partition that you create.

Assign roles to each partition Admin user - The `partitionTool` utility creates a default Admin user for each partition you create. On the **Users** page, assign at least one security role (for example, Global Policy/Admin) to your new user. Once the new user has been assigned the role, you can log into the Unica Campaign partition as that new user.

If you plan to enable Unica Deliver in multiple Unica Campaign partitions, you must configure a corresponding Unica Deliver partition for each Unica Campaign partition. For more information about creating additional partitions for Unica Deliver, see [Configuring multiple partitions in Unica Deliver on page 59](#).

Chapter 8. Configuring multiple partitions for Unica Optimize

In the Unica family of products, partitions provide a way to secure the data that is associated with different groups of users. When you configure Unica Campaign or a related Unica application to operate with multiple partitions, users can see each partition as a separate instance of the application. There is no indication that other partitions exist on the same computer.

How multiple partitions work

For the Unica applications that operate with Unica Campaign, you can configure the application within the partitions where you have configured an instance of Unica Campaign. Application users within each partition can access the Unica Campaign functions, data, and customer tables that are configured for Unica Campaign in the same partition.

Partition benefits

Multiple partitions are useful for setting up strong security between groups of users, because each partition has its own set of Unica Campaign system tables. Multiple partitions cannot be used when groups of users must share data.

Each partition has its own set of configuration settings, and Unica Campaign can be customized for each group of users. However, all partitions share the same installation binaries. With the same binaries for all partitions, you can minimize the installation and upgrade efforts for multiple partitions.

Partition user assignment

Access to partitions is managed through membership in Unica Platform groups.

Except for the partition superuser (platform_admin), each HCL user can belong to one partition. A user who requires access to multiple partitions must have a separate user account for each partition.

If there is only one partition, users do not have to be explicitly assigned to that partition to have access to Unica Campaign.

Partition data access

In a multi-partition configuration, partitions have the following security characteristics:

- A user cannot access a partition if the user is not a member of a group that is assigned to a partition.
- A user of one partition cannot view or change data in another partition.
- Users cannot navigate the Unica Campaign file system above the root directory of their partition from the browse dialog boxes in Unica Campaign. For example, if two partitions, named partition1 and partition2 exist, and you belong to the group that is associated with partition1, you cannot navigate the directory structure for partition2 from a dialog box.

Setting up multiple partitions for Unica Optimize

Use multiple partitions in Unica Optimize so that different groups of users have access to different sets of Unica Optimize and Unica Campaign data.

About this task

With 12.0 release onwards - Unica Optimize is installed along with Unica Campaign. Default partition1 directory created for Campaign is used for Optimize. Additional partition created for Unica Campaign is available for Optimize. Since V 12.0 release, Optimize is coming by default with Campaign application. Once user creates partition it supports the partition for Optimize as well. In other words, if you require partition for Optimize, then you require to create partition for Campaign as well.

Complete the following steps to set up multiple partitions for Unica Optimize:

1. Create your Unica Campaign partitions.
2. Copy the contents of the old ContactOptimization/partitions/partition2 directory, along with all of its (empty) subdirectories, into the directory you created for the new partition.

For example, copy the contents of the partition2 directory into the

Campaign_Home/partitions/partition2 directory

3. Run the SQL scripts to create and populate the Unica Optimize system tables in the database that is configured for the new partition.

For more information about running the SQL scripts, see the "Creating and populating the Unica Optimize system tables manually" topic.

4. Repeat Steps 2 through 4 for each partition you must create. Use the most recently created directory as your starting point.



Note: By default, partitions are installed under the partitions directory.

Results

Chapter 9. Configuring multiple partitions in Unica Deliver

Configure multiple partitions in Unica Deliver to isolate and secure data for different groups of Unica Deliver users. As each partition has its own set of configuration properties, you can customize Unica Deliver for each group of users.

Installing Unica Deliver creates a default partition for Unica Deliver in the Unica Platform. You can configure more partitions for Unica Deliver. Each partition that you create for Unica Deliver operates in conjunction with a partition created for Unica Campaign.



Note: To configure multiple partitions in Unica Deliver you must configure corresponding partitions in Unica Campaign.

Adding new partitions for Unica Deliver requires making changes in the Unica Platform configurations for Unica Deliver and Unica Campaign.



Important: After you change the Unica Deliver and Unica Campaign configurations, you must restart the web application server that hosts Unica Campaign and restart the Response and Contact Tracker (RCT). You might also need to restart the Unica Campaign listener.

Be sure to back up your existing configurations before you make changes.

Partitions for Unica Deliver: Overview

Creating partitions for Unica Deliver allows you to isolate and secure data for different groups of users. Each partition appears to users as a separate instance of Unica Deliver, with no indication that other partitions exist on the same system. Because each partition has its own set of configuration properties, you can customize Unica Deliver for each group of users.

Users within each partition can access only those functions, data, and customer tables configured for the partition. For example, if you create partitions named `partition1` and `partition2`, Unica Deliver users working in `partition1` can select email recipients from customer tables configured in `partition1`, but not in `partition2`. HCL does not recommend creating multiple partitions if users need to share data.

When you work with multiple partitions, you should understand characteristics that are unique to partitions for Unica Deliver and how partitions for Unica Deliver relate to partitions for Unica Campaign. You should also be familiar with the workflow for creating and configuring multiple partitions for Unica Deliver.

Characteristics of partitions for Unica Deliver

Note the following when you create and configure new partitions for Unica Deliver.

- You create partitions for Unica Deliver differently than you do for Unica Campaign.
You create new partitions for Unica Deliver using a partition template available in the Deliver configuration properties in Unica Platform.
- The name of each Unica Deliver partition must exactly match the name of its corresponding Unica Campaign partition.

- Each partition that you create for Unica Deliver must be able to connect to HCL Unica.

You must request a separate HCL Unica account for each partition. will provide a user name and password connected to the account. You must configure a Unica Platform data source that can provide these access credentials automatically when Unica Deliver connects to HCL Unica.

For more information about how to request an account, see the *Unica Deliver Startup and Administrator's Guide*.

Relationship to partitions in Unica Campaign

Each partition in Unica Deliver operates in conjunction with a specific partition created in the Unica Platform for Unica Campaign. The Unica Campaign partition provides the following.

- Unica Campaign schema that contains the Deliver system tables
- File structure for Unica Campaign in the partition, including directories used by Unica Deliver to create and process recipient lists
- Configuration properties associated with creating recipient lists and enabling Unica Deliver within the partition

Because Unica Deliver operates with Unica Campaign within a specific partition, the Unica Deliver and Unica Campaign partition structures must specify the same name. The partition names must match exactly.

Roadmap for configuring multiple partitions in Unica Deliver

To create a partition in Unica Deliver, use the exact same name as the partition in Unica Campaign that exists in the Unica Platform configurations.

Before you create a new partition for Unica Deliver, confirm that you have satisfied all the Unica Deliver prerequisites for the partition in Unica Campaign and Unica Deliver.

Complete the following steps to create a new partition for Unica Deliver.

1. [Creating a new partition for Unica Deliver on page 60](#)
2. [Preparing Unica Deliver system tables for the partition on page 62](#)
3. [Configuring a system user to access HCL Unica on page 64](#)
4. [Enabling Unica Deliver in Unica Campaign for the new partition on page 65](#)
5. [Specifying the Recipient List Uploader location for Unica Deliver on page 65](#)
6. [Restarting system components after configuring Unica Deliver on page 65](#)
7. [Testing Unica Deliver partition configuration and connections on page 66](#)

Creating a new partition for Unica Deliver

Installing Unica Deliver creates a default partition for Unica Deliver in Unica Platform. You can create multiple partitions for Unica Deliver to isolate and secure data for different groups of users.

Before you begin

Before you create and configure partitions for Unica Deliver, you must meet the following requirements for Unica Deliver and Unica Campaign:

- Before you create multiple partitions in Unica Deliver, complete the following tasks for Unica Deliver:
 - Contact Support to request an account and credentials for each partition. Each partition requires a separate Unica Journey account and access credentials. For more information, *Unica Deliver Startup and Administrator's Guide*.
 - Create a system user that can access the Unica Deliver system tables that you will create in the Unica Campaign schema for the partition.

You can update the system user that you created for the Unica Campaign partition so that it can also access the Unica Deliver system tables.

- Before you create multiple partitions in Unica Deliver, complete the following tasks in Unica Campaign:
 - Create a partition in Unica Campaign to operate with the partition that you are creating for Unica Deliver. Note the name of the partition.
 - Create Unica Campaign system tables in the Unica Campaign partition.
 - Configure a system user to access the system tables in the partition.

If you have multiple partitions, each partition must have its own system user. The system user cannot be the same across partitions.

About this task

The installer registers the Unica Deliver configuration properties and a default partition during initial installation. The default partition includes a template that you can copy to create additional partitions.

Complete the following actions to create a new partition for Unica Deliver:

1. Navigate to `Deliver > partitions > (partition)` and duplicate the partition template.
2. Name the new partition.



Note: Unica Deliver does not support deleting a partition after you have created it.

Example

Identifying the partition template

The Configuration page displays the Unica Deliver partition template in the navigation tree for the default partition. You can identify the partition template in the tree because its label is in italics and enclosed in parentheses.

What to do next

Naming the new partition

The following restrictions apply when you name a new partition.

- The name must be unique among categories that are siblings in the tree (that is, among categories that share the same parent category).
- The partition name may not start with a period. Also, the following characters are not allowed in partition names.

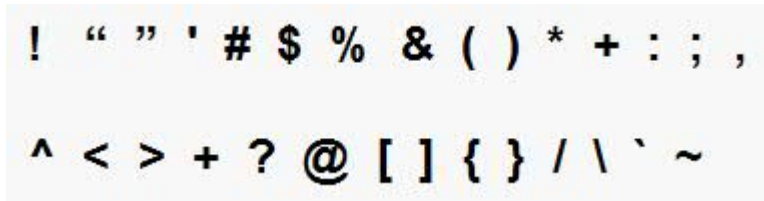

Note: Because Unica Deliver operates with Unica Campaign within a specific partition, the partitions for Unica Deliver and Unica Campaign must specify the same partition name.

Preparing Unica Deliver system tables for the partition

For each partition that you create for Unica Deliver, you must create, populate and configure the Unica Deliver system tables that are used by the partition in the Unica Campaign schema.

Complete the following actions to prepare the Unica Deliver system tables for a partition:

1. Create the Unica Deliver system tables.

In your database client, run the SQL scripts for *creating* system tables against the Unica Campaign database.

2. Populate the tables that you created.

Use the database client to run the scripts for *populating* tables against the Unica Campaign database. For more information about the SQL scripts, see the reference table for script names and locations at [Creating and populating the Unica Deliver system tables manually on page 63](#).

3. Set the following configuration properties in the Deliver configuration for the partition, specifying the user name and platform data source that you configured for the partition's Unica Campaign system user:

- Deliver > partitions > partition [n] < dataSources > systemTables > asmUserForDBCredentials
- Deliver > partitions > partition [n] < dataSources > systemTables > amDataSourceForDBCredentials

Unica Deliver accesses the partition's system tables through a system user configured in Unica Platform. A Unica Platform data source added to the system user provides the required access credentials. Because the Unica Deliver system tables exist in the Unica Campaign schema for the partition, you can use the system user that you created to access the Unica Campaign schema to access the partition's Unica Deliver system tables.

4. Update the following properties in the partition's configuration properties:

- Deliver > partitions > partition [n] < dataSources > systemTables > type
- Deliver > partitions > partition [n] < dataSources > systemTables > schemaName
- Deliver > partitions > partition [n] < dataSources > systemTables > jdbcBatchSize
- Deliver > partitions > partition [n] < dataSources > systemTables > jdbcClassName
- Deliver > partitions > partition [n] < dataSources > systemTables > jdbcURI

See the Unica Platform online help for each property to learn more about setting the configuration properties. For additional information about these configuration properties and configuring Unica Deliver, see the *Unica Deliver Startup and Administrator's Guide*.

Creating and populating the Unica Deliver system tables manually

For Unica Deliver, you must create additional system tables in the Unica Campaign schema and then populate the tables with initial data. The Unica Campaign installer automatically creates and populates the Unica Deliver system tables in the Unica Campaign schema if you select the option to create system tables automatically. However, if you do not select the option, you must create and populate the Unica Deliver system tables manually.

Use your database client to run the appropriate script against the Unica Campaign database.



Note: The Unica Deliver installation directory is a subfolder within the Unica Campaign directory.

Scripts for creating Unica Deliver tables

Campaign provides the `ace_op_systab` scripts for creating Unica Deliver tables in your local environment.

If your Unica Campaign system tables are configured for Unicode, find the appropriate script in the `ddl/unicode` directory under your Unica Deliver installation.

If your Unica Campaign system tables are not configured for Unicode, use the non-Unicode scripts in the `ddl` directory under your Unica Deliver installation. Use the following table to see the scripts that you must use:

Table 10. Scripts for creating Unica Deliver tables

| Data source type | Script name |
|-----------------------|---|
| IBM® DB2® | ace_op_systab_db2.sql The user tablespace and system temporary tablespace where the system tables reside must each have a page size of 16K or greater. |
| Microsoft™ SQL Server | ace_op_systab_sqlsvr.sql |
| MariaDB | ace_op_systab_mariadb.sql |
| Oracle | ace_op_systab_ora.sql |
| Postgres | ace_op_systab_pgsql.sql |

Scripts for populating Unica Deliver tables

HCL provides the `ace_op_populate_systab` scripts for populating the Unica Deliver tables in your local environment.

The populate scripts are stored in the `ddl` directory of your Unica Deliver installation. HCL provides only one version of the populate scripts because you can use them for either Unicode or non-Unicode tables.



Note: The Unica Deliver installation directory is a subfolder within the Unica Campaign directory.

Use the following table to see the scripts that you must use:

Table 11. Scripts for populating Unica Deliver tables

| Data source type | Script name |
|-----------------------|------------------------------------|
| IBM® DB2® | ace_op_populate_systab_db2.sql |
| MariaDB | ace_op_populate_systab_mariadb.sql |
| Microsoft™ SQL Server | ace_op_populate_systab_sqlsvr.sql |
| Oracle | ace_op_populate_systab_ora.sql |
| Postgres | ace_op_populate_systab_pgsql.sql |

Configuring a system user to access HCL Unica

Unica Deliver components must be able to access the HCL Unica without requiring manual entry of login credentials. To establish automatic login, define a system user in Unica Platform that can provide the required access credentials.

To simplify user administration and troubleshooting, you can modify an existing system user to access hosted services and local system tables. You can configure a single system user to provide credentials for multiple systems. For example, modifying the configuration of the Unica Campaign system user creates a single user that can automatically access HCL Unica and the Unica Deliver system tables in the Unica Campaign schema.

The credentials required to access HCL Unica are the user name and password that HCL provides for your hosted messaging account.

For specific information about how to configure a system user to communicate with HCL Unica, see the *Unica Deliver Startup and Administrator's Guide*.

For general information about how to create system users and data sources, see the *Unica Platform Administrator's Guide*.

Configuring partition access to HCL Unica

Unica Deliver components in the partition must be allowed to automatically provide valid login credentials when attempting to communicate with HCL Unica. To do this, you must add the HCL Unica login credentials to a Unica Platform user. This user becomes the Unica Deliver system user.

You can add the platform data source containing the HCL Unica credentials to the Unica Deliver system user. This user can be the same system user that accesses the Unica Campaign system tables in the partition.

The steps for configuring system users for a partition are the same as those followed during the initial Unica Deliver installation, which created the first partition. For details about how to add login credentials to a system user, see the *Unica Deliver Startup and Administrator's Guide*.

The credentials required to access HCL Unica are the user name and password that HCL provided during the initial startup process.

 **Important:** For each additional partition, you must request a separate user name and password from HCL.

Enabling Unica Deliver in Unica Campaign for the new partition

To allow users of the new Unica Deliver partition to access the Unica Deliver features in Unica Campaign, enable Unica Deliver in the Unica Campaign partition by updating the `deliverInstalled` configuration property for the corresponding Unica Campaign partition.

About this task

For example, the Unica Deliver mailing tab does not appear in the Unica Campaign interface until you enable Unica Deliver in the Unica Campaign configuration.

You enable Unica Deliver in the partition by updating the `deliverInstalled` configuration property for the corresponding Unica Campaign partition.

In the Unica Platform configurations, navigate to **Campaign | partitions | partition[n] | server | internal** and set the `deliverInstalled` property to `yes`.

Specifying the Recipient List Uploader location for Unica Deliver

For each partition where you enable Unica Deliver, specify the location of the Recipient List Uploader (RLU). The RLU uploads the output list tables data and associated metadata to the remote services hosted by HCL.

About this task

During initial installation, the Unica Campaign installer automatically adds the location of the RLU to the configuration for default partition (`partition1`). However, when you add new partitions to your environment, you must manually configure all new partitions to reference the correct location. Because there is only one RLU for each Unica Deliver installation, all partitions access the same plugin file in the local file system of the machine that hosts the Unica Campaign web application.

1. In the configuration for **partition1** in your Unica Campaign installation, navigate to `Campaign > partitions > partition1 > Deliver > deliverPluginJarFile`.

The value for this property is the full path to the plugin file (`deliverplugin.jar`) that operates as the RLU.

For example: `C:\Unica\Deliver\plugin\deliverplugin.jar`

2. Copy the value for the `DeliverPluginJarFile` property.
3. Navigate to the `DeliverPluginJarFile` for the new partition and enter the path you copied from **partition1**.

All partitions must use the same location for the RLU.

Restarting system components after configuring Unica Deliver

After you change the Unica Deliver and Unica Campaign configurations, you must restart the Unica Campaign web application server, the Response and Contact Tracker (RCT), and the Unica Campaign listener.

1. Restart the web application server for Unica Campaign.

For instructions, see the documentation for your web application server.

To verify that the server has started, log in to your Unica installation, access Unica Campaign, and confirm that you can open an existing mailing.

2. Restart the Response and Contact Tracker (RCT).

Example

To restart the RCT manually, run the `rct` script in the `bin` directory under your Unica Deliver installation, as follows: `rct start`.

To stop the RCT manually run the `rct` script in the `bin` directory under your Unica Deliver installation, as follows: `rct stop`.

If RCT is configured to run as a service, restart the RCT service. The first time that you restart the RCT as a service, you must manually restart the RCT afterward.

For more information, see [Unica Deliver Response and Contact Tracker \(RCT\) script on page 82](#).

3. Restart the Unica Campaign listener:

Example

- On Windows™, run the `cmpServer.bat` file in the `bin` directory under your Unica Campaign installation.
- On UNIX™, run the following command as root: `./rc.unica_ac start`

Results

Testing Unica Deliver partition configuration and connections

Run the RLU script provided by Unica Deliver to verify the partition configuration and its connection to HCL Unica. You must also confirm if you can access the mailing interface from the partition.

Before you begin



Important: Before you begin, if you have changed the Unica Campaign or Unica Deliver configurations, confirm that you have restarted the web application server that hosts Unica Campaign and that you have restarted the Response and Contact Tracker.

About this task

For more information on how to test the partition, see the *Unica Deliver Startup and Administrator's Guide*.

Chapter 10. Unica Platform utilities

This section provides an overview of the Unica Platform utilities, including some details that apply to all the utilities and which are not included in the individual utility descriptions.

Location of utilities

Unica Platform utilities are located in the `tools/bin` directory under your Unica Platform installation.

List and descriptions of utilities

The Unica Platform provides the following utilities.

- `Clientdetails` - generates a key for a client application like Unica Journey to authenticate with one Unica Platform instance.
- [alertConfigTool on page 69](#) - registers alerts and configurations for Unica products
- [configTool on page 69](#) - imports, exports, and deletes configuration settings, including product registrations
- [datafilteringScriptTool on page 73](#) - creates data filters
- [encryptPasswords on page 75](#) - encrypts and stores passwords
- `encryptTomcatDBPasswords` - encrypt the database passwords that the Tomcat Application server uses internally
- [partitionTool on page 76](#) - creates database entries for partitions
- [populateDb on page 78](#) - populates the Unica Platform database
- `quartzjobtool` - Update scheduler jobs created in version 11.1 and older versions
- [restoreAccess on page 79](#) - restores a user with the `platformAdminRole` role
- [scheduler_console_client on page 80](#) - lists or starts Unica Scheduler jobs that are configured to listen for a trigger.
- `insightsdbutil` - Installer places report design files which possesses database connection tokens. You must update them for your system database. You must run `insightsdbutil.sh/bat` utility to update the same. See the Unica Insights Installation and Configuration Guide for more details.

Prerequisites for running Unica Platform utilities

The following are prerequisites for running all Unica Platform utilities.

- Run all utilities from the directory where they are located (by default, the `tools/bin` directory under your Unica Platform installation).
- On UNIX™, the best practice is to run the utilities with the same user account that runs the application server on which Unica Platform is deployed. If you run a utility with a different user account, adjust the permissions on the `platform.log` file to allow that user account to write to it. If you do not adjust permissions, the utility is not able to write to the log file and you might see some error messages, although the tool should still function correctly.

Authentication of utilities

Utilities such as `configTool` and other Unica back end utilities are designed to be used by system administrators and require physical access to the host servers for them to be invoked. For this reason, authentication for these utilities has

been designed to be independent of the UI authentication mechanism. Access to these utilities is available to users with Unica Platform administrator privileges. Access to these utilities is expected to be locally defined in Unica Platform and authenticated against the same.

Troubleshooting connection issues

All of the Unica Platform utilities except `encryptPasswords` interact with the Unica Platform system tables. To connect to the system table database, these utilities use the following connection information, which is set by the installer using information provided when the Unica Platform was installed. This information is stored in the `jdbc.properties` file, located in the `tools/bin` directory under your Unica Platform installation.

- JDBC driver name
- JDBC connection URL (which includes the host, port, and database name)
- Data source login
- Data source password (encrypted)

In addition, these utilities rely on the `JAVA_HOME` environment variable, set either in the `setenv` script located in the `tools/bin` directory of your Unica Platform installation, or on the command line. The Unica Platform installer should have set this variable automatically in the `setenv` script, but it is a good practice to verify that the `JAVA_HOME` variable is set if you have a problem running a utility. The JDK must be the Sun version (not, for example, the JRockit JDK available with WebLogic).

Special characters

Characters that are designated as reserved characters in the operating system must be escaped. Consult your operating system documentation for a list of reserved characters and how to escape them.

Standard options in Unica Platform utilities

The following options are available in all Unica Platform utilities.

`-l logLevel`

Set the level of log information displayed in the console. Options are `high`, `medium`, and `low`. The default is `low`.

`-L`

Set the locale for console messages. The default locale is `en_US`. The available option values are determined by the languages into which the Unica Platform has been translated. Specify the locale using the ICU locale ID according to ISO 639-1 and ISO 3166.

`-h`

Display a brief usage message in the console.

`-m`

Display the manual page for this utility in the console.

`-v`

Display more execution details in the console.

Utilities

This section describes the Unica Platform utilities, with functional details, syntax, and examples.

alertConfigTool

Notification types are specific to the various Unica products. Use the `alertConfigTool` utility to register the notification types when the installer has not done this automatically during installation or upgrade.

Syntax

```
alertConfigTool -i -f importFile
```

Commands

```
-i -f importFile
```

Import alert and notification types from a specified XML file.

Example

- Import alert and notification types from a file named `Platform_alerts_configuration.xml` located in the `tools\bin` directory under the Unica Platform installation.

```
alertConfigTool -i -f Platform_alerts_configuration.xml
```

configTool

The properties and values on the **Configuration** page are stored in the Unica Platform system tables. You can use the `configTool` utility to import and export configuration settings to and from the system tables.

When to use configTool

You might want to use `configTool` for the following reasons.

- To import partition and data source templates that are supplied with Unica Campaign, which you can then modify and duplicate by using the **Configuration** page.
- To register (import configuration properties for) Unica products, if the product installer is unable to add the properties to the database automatically.
- To export an XML version of configuration settings for backup or to import into a different installation of Unica.
- To delete categories that do not have the **Delete Category** link. You do this by using `configTool` to export your configuration, then manually deleting the XML that creates the category and by using `configTool` to import the edited XML.



Important: This utility modifies the `usm_configuration` and `usm_configuration_values` tables in the Unica Platform system table database, which contains the configuration properties and their values. For best results, either create



backup copies of these tables, or export your existing configurations by using `configTool` and back up the resulting file so you have a way to restore your configuration if you make an error when you use `configTool` to import.

Syntax

```
configTool -d -p "elementPath" [-o]
```

```
configTool -i -p "parent ElementPath" -f importFile [-o]
```

```
configTool -x -p "elementPath" -f exportFile
```

```
configTool -vp -p "elementPath" -f importFile [-d]
```

```
configTool -r productName -f registrationFile [-o] configTool -u productName
```

Commands

```
-d -p "elementPath" [o]
```

Delete configuration properties and their settings, specifying a path in the configuration property hierarchy.

The element path must use the internal names of categories and properties. You can obtain them by going to the **Configuration** page, selecting the wanted category or property, and looking at the path that is displayed in parentheses in the right pane. Delimit a path in the configuration property hierarchy by using the `|` character, and surround the path with double quotation marks.

Note the following.

- Only categories and properties within an application can be deleted by using this command, not whole applications. Use the `-u` command to unregister a whole application.
- To delete categories that do not have the **Delete Category** link on the **Configuration** page, use the `-o` option.

When you use `-d` with the `-vp` command, the `configTool` deletes any child nodes in the path you specify if those nodes are not included in the XML file you specify.

```
-i -p "parentElementPath" -f importFile [o]
```

Import configuration properties and their settings from a specified XML file.

To import, you specify a path to the parent element under which you want to import your categories. The `configTool` utility imports properties under the category you specify in the path.

You can add categories at any level below the top level, but you cannot add a category at same level as the top category.

The parent element path must use the internal names of categories and properties. You can obtain them by going to the **Configuration** page, selecting the required category or property, and looking at the path that is displayed in parentheses in the right pane. Delimit a path in the configuration property hierarchy by using the `|` character and surround the path with double quotation marks.

You can specify an import file location relative to the `tools/bin` directory or you can specify a full directory path. If you specify a relative path or no path, `configTool` first looks for the file relative to the `tools/bin` directory.

By default, this command does not overwrite an existing category, but you can use the `-o` option to force an overwrite.

```
-x -p "elementPath" -f exportFile
```

Export configuration properties and their settings to an XML file with a specified name.

You can export all configuration properties or limit the export to a specific category by specifying a path in the configuration property hierarchy.

The element path must use the internal names of categories and properties, which you can obtain by going to the **Configuration** page, selecting the wanted category or property, and looking at the path that is displayed in parentheses in the right pane. Delimit a path in the configuration property hierarchy by using the | character and surround the path with double quotation marks.

You can specify an export file location relative to the current directory or you can specify a full directory path. If the file specification does not contain a separator (/ on UNIX™, / or \ on Windows™), `configTool` writes the file to the `tools/bin` directory under your Unica Platform installation. If you do not provide the `xml` extension, `configTool` adds it.

```
-vp -p "elementPath" -f importFile [-d]
```

This command is used mainly in manual upgrades, to import configuration properties. If you applied a fix pack that contains a new configuration property, and you then upgrade, importing a configuration file as part of a manual upgrade process can override values that were set when the fix pack was applied. The `-vp` command ensures that the import does not override previously set configuration values.



Important: After you use the `configTool` utility with the `-vp` option, you must restart the web application server on which Unica Platform is deployed so the changes are applied.

When you use `-d` with the `-vp` command, the `configTool` deletes any child nodes in the path you specify if those nodes are not included in the XML file you specify.

```
-r productName -f registrationFile
```

Register the application. The registration file location can be relative to the `tools/bin` directory or can be a full path. By default, this command does not overwrite an existing configuration, but you can use the `-o` option to force an overwrite. The `productName` parameter must be one of those names that are listed above.

Note the following.

- When you use the `-r` command, the registration file must have `<application>` as the first tag in the XML. Other files can be provided with your product that you can use to insert configuration properties into the Unica Platform database. For these files, use the `-i` command. Only the file that has the `<application>` tag as the first tag can be used with the `-r` command.
- The registration file for the Unica Platform is named `Manager_config.xml`, and the first tag is `<Suite>`. To register this file on a new installation, use the `populateDb` utility, or rerun the Unica Platform installer as described in the *Unica Platform Installation Guide*.
- After the initial installation, to re-register products other than the Unica Platform, use `configTool` with the `-r` command and `-o` to overwrite the existing properties.

The `configTool` utility uses product names as parameters with the commands that register and unregister products. With the 8.5.0 release of Unica, many product names changed. However, the names that are recognized by `configTool` did not change. The valid product names for use with `configTool` are listed below, along with the current names of the products.

Table 12. Product names for configTool registration and unregistration

| Product name | Name used in configTool |
|--|-------------------------|
| Unica Platform | Manager |
| Unica Campaign | Campaign |
| Unica Collaborate | Collaborate |
| Unica Deliver | Deliver |
| Unica Journey | Journey |
| Unica Insights | UnicaInsights |
| Unica Content Integration | assetPicker |
| Unica Offer | Offer |
| Unica Interact | interact |
| Unica Optimize | Optimize |
| Unica Plan | Plan |
| Opportunity Detect | Detect |
| IBM SPSS Modeler Advantage Enterprise Marketing Management Edition | SPSS |
| Digital Analytics | Coremetrics |

`-u productName`

Unregister an application that is specified by `productName`. You do not have to include a path to the product category; the product name is sufficient, and it is required. The process removes all properties and configuration settings for the product.

Options

`-o`

When used with `-i` or `-r`, it overwrites an existing category or product registration (node).

When used with `-d`, you can delete a category (node) that does not have the **Delete Category** link on the **Configuration** page.

Examples

- Import configuration settings from a file named `Product_config.xml` in the `conf` directory under the Unica Platform installation.

```
configTool -i -p "Affinium" -f Product_config.xml
```

- Import one of the supplied Unica Campaign data source templates into the default Unica Campaign partition, `partition1`. The example assumes that you placed the Oracle data source template, `OracleTemplate.xml`, in the `tools/bin` directory under the Unica Platform installation.

```
configTool -i -p "Affinium|Campaign|partitions|partition1|dataSources" -f OracleTemplate.xml
```

- Export all configuration settings to a file named `myConfig.xml` in the `D:\backups` directory.

```
configTool -x -f D:\backups\myConfig.xml
```

- Export an existing Unica Campaign partition (complete with data source entries), save it to a file named `partitionTemplate.xml`, and store it in the default `tools/bin` directory under the Unica Platform installation.

```
configTool -x -p "Affinium|Campaign|partitions|partition1" -f partitionTemplate.xml
```

- Manually register an application named `productName`, by using a file named `app_config.xml` in the default `tools/bin` directory under the Unica Platform installation, and force it to overwrite an existing registration of this application.

```
configTool -r product Name -f app_config.xml -o
```

- Unregister an application named `productName`.

```
configTool -u productName
```

- Run the following command to enable `encodeCSV` feature:

```
configTool -vp -p "Affinium|Plan|umoConfiguration" -f Plan_Home\conf\Plan_encodeProperty_11.1.xml
```

- Register Unica Interact Settings as configuration menu under `AffiniumWebApps\Campaign\interact\conf\interact_setup_navigation.xml` using

```
configTool.bat -v -i -p "Affinium|suite|uiNavigation|settingsMenu" -f "interact_setup_navigation.xml"
```

datafilteringScriptTool

The `datafilteringScriptTool` utility reads an XML file to populate the data filtering tables in the Unica Platform system table database.

Depending on how you write the XML, you can use this utility in two ways.

- Using one set of XML elements, you can auto-generate data filters based on unique combinations of field values (one data filter for each unique combination).
- Using a slightly different set of XML elements, you can specify each data filter that the utility creates.

See *Unica Platform the Administrator's Guide* for information about creating the XML.

When to use `datafilteringScriptTool`

You must use `datafilteringScriptTool` when you create new data filters.

Prerequisites

The Unica Platform must be deployed and running.

Using `datafilteringScriptTool` with SSL

When the Unica Platform is deployed using one-way SSL you must modify the `datafilteringScriptTool` script to add the SSL options that perform handshaking. To modify the script, you must have the following information.

- Truststore file name and path
- Truststore password

In a text editor, open the `datafilteringScriptTool` script (`.bat` or `.sh`) and find the lines that look like this (examples are Windows™ version).

```
:callexec
"%JAVA_HOME%\bin\java" -DUNICA_PLATFORM_HOME="%UNICA_PLATFORM_HOME%"
com.unica.management.client.datafiltering.tool.DataFilteringScriptTool %*
```

Edit these lines to look like this (new text is in **bold**). Substitute your truststore path and file name and truststore password for `myTrustStore.jks` and `myPassword`.

```
:callexec
SET SSL_OPTIONS=-Djavax.net.ssl.keyStoreType="JKS"
-Djavax.net.ssl.trustStore="C:\security\myTrustStore.jks"
-Djavax.net.ssl.trustStorePassword=myPassword
"%JAVA_HOME%\bin\java" -DUNICA_PLATFORM_HOME="%UNICA_PLATFORM_HOME%" %SSL_OPTIONS%
com.unica.management.client.datafiltering.tool.DataFilteringScriptTool %*
```

Syntax

```
datafilteringScriptTool -r pathfile
```

Commands

```
-r path_file
```

Import data filter specifications from a specified XML file. If the file is not located in the `tools/bin` directory under your installation, provide a path and enclose the `path_file` parameter in double quotation marks.

Example

- Use a file named `collaborateDataFilters.xml`, located in the `C:\unica\xml` directory, to populate the data filter system tables.

```
datafilteringScriptTool -r "C:\unica\xml\collaborateDataFilters.xml"
```

encryptPasswords

The `encryptPasswords` utility is used to encrypt and store either of two passwords that Unica Platform uses internally.

The two passwords that the utility can encrypt are as follows.

- The password that the Unica Platform uses to access its system tables. The utility replaces an existing encrypted password (stored in the `jdbc.properties` file, located in the `tools\bin` directory under your Unica Platform installation) with a new one.
- The keystore password used by the Unica Platform when it is configured to use SSL with a certificate other than the default one supplied with the Unica Platform or the web application server. The certificate can be either a self-signed certificate or a certificate from a certificate authority.

When to use encryptPasswords

Use `encryptPasswords` as for the following reasons.

- When you change the password of the account used to access your Unica Platform system table database.
- When you have created a self-signed certificate or have obtained one from a certificate authority.

Prerequisites

- Before running `encryptPasswords` to encrypt and store a new database password, make a backup copy of the `jdbc.properties` file, located in the `tools/bin` directory under your Unica Platform installation.
- Before running `encryptPasswords` to encrypt and store the keystore password, you must have created or obtained a digital certificate and know the keystore password.

Syntax

```
encryptPasswords -d databasePassword
```

```
encryptPasswords -k keystorePassword
```

Commands

-d *databasePassword*

Encrypt the database password.

-k *keystorePassword*

Encrypt the keystore password and store it in a file named `pfile`.

Examples

- When the Unica Platform was installed, the login for the system table database account was set to `myLogin`. Now, some time after installation, you have changed the password for this account to `newPassword`. Run `encryptPasswords` as follows to encrypt and store the database password.

```
encryptPasswords -d newPassword
```

- You are configuring an Unica application to use SSL and have created or obtained a digital certificate. Run `encryptPasswords` as follows to encrypt and store the keystore password.

```
encryptPasswords -k myPassword
```

partitionTool

Partitions are associated with Unica Campaign policies and roles. These policies and roles and their partition associations are stored in the Unica Platform system tables. The `partitionTool` utility seeds the Unica Platform system tables with basic policy and role information for partitions.

When to use partitionTool

For each partition you create, you must use `partitionTool` to seed the Unica Platform system tables with basic policy and role information.

See the installation guide appropriate for your version of Unica Campaign for detailed instructions on setting up multiple partitions in Unica Campaign.

Special characters and spaces

Any partition description or user, group, or partition name that contains spaces must be enclosed in double quotation marks.

Syntax

```
partitionTool -c -s sourcePartition -n newPartitionName [-u admin_user_name] [-d partitionDescription] [-g groupName]
[-a application]
```

Commands

The following commands are available in the `partitionTool` utility.

`-c`

Replicates (clones) the policies and roles for an existing partition specified using the `-s` option, and uses the name specified using the `-n` option. Both of these options are required with `c`. This command does the following.

- Creates a new Unica user with the Admin role in both the Administrative Roles policy and the global policy in Unica Campaign. The partition name you specify is automatically set as this user's password.
- Creates a new Unica Platform group and makes the new Admin user a member of that group.
- Creates a new partition object.
- Replicates all the policies associated with the source partition and associates them with the new partition.

- For each replicated policy, replicates all roles associated with the policy.
- For each replicated role, maps all functions in the same way that they were mapped in the source role.
- Assigns the new Unica Platform group to the last system-defined Admin role created during role replication. If you are cloning the default partition, partition1, this role is the default Administrative Role (Admin).

Options

-d *partitionDescription*

Optional, used with `-c` only. Specifies a description that appears in the output from the `-list` command. Must be 256 characters or less. Enclose in double quotation marks if the description contains spaces.

-a *application*

Optional, used with `-c`, `-n`, `-g`, and `-u` only . Clones data from the source partition for the specified application only partition. The application must be Unica Suite application.

-g *groupName*

Optional, used with `-c` only. Specifies the name of the Unica Platform Admin group that the utility creates. The name must be unique within this instance of Unica Platform

If not defined, the name defaults to `partition_nameAdminGroup`.

-n *partitionName*

Optional with `-list`, required with `-c`. Must be 32 characters or less.

When used with `-list`, specifies the partition whose information is listed.

When used with `-c`, specifies the name of the new partition, and the partition name you specify is used as the password for the Admin user. The partition name must match the name you gave the partition in when you configured it (using the partition template on the Configuration page).

-s *sourcePartition*

Required, used with `-c` only. The name of the source partition to be replicated.

-u *adminUserName*

Optional, used with `-c` only. Specifies the user name of the Admin user for the replicated partition. The name must be unique within this instance of Unica Platform.

If not defined, the name defaults to `partitionNameAdminUser`.

The partition name is automatically set as this user's password.

Examples

- Create a partition with the following characteristics.
 - Cloned from partition1
 - Partition name is `myPartition`
 - Uses the default user name (`myPartitionAdminUser`) and password (`myPartition`)
 - Uses the default group name (`myPartitionAdminGroup`)

- Description is "ClonedFromPartition1"
- `partitionTool -c -s partition1 -n myPartition -d "ClonedFromPartition1"`
- Create a partition with the following characteristics.
 - Cloned from partition1
 - Partition name is `partition2`
 - Specifies user name of `customerA` with the automatically assigned password of `partition2`
 - Specifies group name of `customerAGroup`
 - Description is "PartitionForCustomerAGroup"
 - `partitionTool -c -s partition1 -n partition2 -u customerA -g customerAGroup -d "PartitionForCustomerAGroup"`
- Update a partition with the following characteristics.
 - Cloned from partition1
 - Partition name is `partition2`
 - Specify admin user name and admin user group of `partition2`
 - `partitionTool -c -s partition1 -n partition2 -u partition2AdminUser -a Journey`



Note: While using `-a` option ensure to specify the group name, if the group name was specified explicitly when partition was created by utility.

```
partitionTool -c -s partition1 -n partition2 -u partition2AdminUser -g [partition2 group name] -a Journey
```

populateDb

The `populateDb` utility inserts default (seed) data in the Unica Platform system tables.

The Unica installer can populate the Unica Platform system tables with default data for Unica Platform and for Unica Campaign. However, if your company policy does not permit the installer to change the database, or if the installer is unable to connect with the Unica Platform system tables, you must insert default data in the Unica Platform system tables using this utility.

For Unica Campaign, this data includes security roles and permissions for the default partition. For Unica Platform, this data includes default users and groups, and security roles and permissions for the default partition.

Syntax

```
populateDb -n productName
```

Commands

```
-n productName
```

Insert default data into the Unica Platform system tables. Valid product names are `Manager` (for Unica Platform) and `Campaign` (for Unica Campaign).

Examples

- Insert Unica Platform default data manually.

```
populateDb -n Manager
```

- Insert Unica Campaign default data manually.

```
populateDb -n Campaign
```

restoreAccess

The `restoreAccess` utility allows you to restore access to Unica Platform if all users with PlatformAdminRole privileges have been inadvertently locked out or if all ability to log in to the Unica Platform has been lost.

When to use restoreAccess

You might want to use `restoreAccess` under the two circumstances described in this section.

PlatformAdminRole users disabled

It is possible that all users with PlatformAdminRole privileges in Unica Platform might become disabled in the system. Here is an example of how the platform_admin user account might become disabled. Suppose you have only one user with PlatformAdminRole privileges (the platform_admin user). Assume the `Maximum failed login attempts allowed` property in the **General | Password settings** category on the Configuration page is set to 3. Then suppose someone who is attempting to log in as platform_admin enters an incorrect password three times in a row. These failed login attempts cause the platform_admin account to become disabled in the system.

In that case, you can use `restoreAccess` to add a user with PlatformAdminRole privileges to the Unica Platform system tables without accessing the web interface.

When you run `restoreAccess` in this way, the utility creates a user with the login name and password you specify, and with PlatformAdminRole privileges.

If the user login name you specify exists in Unica Platform as an internal user, that user's password is changed.

Only a user with the login name of PlatformAdmin and with PlatformAdminRole privileges can universally administer all dashboards. So if the platform_admin user is disabled and you create a user with `restoreAccess`, you should create a user with a login of platform_admin.

Improper configuration of NTLMv2 authentication

If you implement NTLMv2 authentication with improper configuration and can no longer log in, use `restoreAccess` to restore the ability to log in.

When you run `restoreAccess` in this way, the utility changes the value of the `Platform | Security | Login method` property to `Unica Platform`. This change allows you to log in with any user account that existed before you were locked out. You can optionally specify a new login name and password as well. You must restart the web application server on which Unica Platform is deployed if you use the `restoreAccess` utility in this way.

Password considerations

Note the following about passwords when you use `restoreAccess`.

- The `restoreAccess` utility does not support blank passwords, and does not enforce password rules.
- If you specify a user name that is in use, the utility resets the password for that user.

Syntax

```
restoreAccess -u loginName -p password
```

```
restoreAccess -r
```

Commands

-r

When used without the `-u loginName` option, reset the value of the Platform | Security | Login method property to Unica Platform. Requires restart of the web application server to take effect.

When used with the `-u loginName` option, create a PlatformAdminRole user.

Options

-u loginName

Create a user with PlatformAdminRole privileges with the specified login name. Must be used with the `-p` option.

-p password

Specify the password for the user being created. Required with `-u`.

Examples

- Create a user with PlatformAdminRole privileges. The login name is `tempUser` and the password is `tempPassword`.

```
restoreAccess -u tempUser -p tempPassword
```

- Change the value of the login method to Platform and create a user with PlatformAdminRole privileges. The login name is `tempUser` and the password is `tempPassword`.

```
restoreAccess -r -u tempUser -p tempPassword
```

scheduler_console_client

Jobs configured in the Unica Scheduler can be listed and kicked off by this utility if they are set up to listen for a trigger.

What to do if SSL is enabled

When the Unica Platform web application is configured to use SSL, the JVM used by the `scheduler_console_client` utility must use the same SSL certificate that is used by the web application server on which the Unica Platform is deployed.

Take the following steps to import the SSL certificate

- Determine the location of the JRE used by the `scheduler_console_client`.
 - If `JAVA_HOME` is set as a system environment variable, the JRE it points to is the one used by the `scheduler_console_client` utility.
 - If `JAVA_HOME` is not set as a system environment variable, the `scheduler_console_client` utility uses the JRE set either in the `setenv` script located in the `tools/bin` directory of your Unica Platform installation or on the command line.
- Import the SSL certificate used by the web application server on which the Unica Platform is deployed to the JRE used by `scheduler_console_client`.

The Sun JDK includes a program called `keytool` that you can use to import the certificate. Consult the Java™ documentation for complete details on using this program or access the help by entering `-help` when you run the program.



Note: In case of upgrades, JRE shipped with Unica is overwritten so ensure that you reimport certificates in the JRE if you are using the same JRE.

- Open the `tools/bin/schedulerconsoleclient` file in a text editor and add the following properties. These differ depending on the web application server on which Unica Platform is deployed.
 - For WebSphere®, add these properties to the file.
 - Djavax.net.ssl.keyStoreType=JKS
 - Djavax.net.ssl.keyStore="*Path to your key store JKS file*"
 - Djavax.net.ssl.keyStorePassword="*Your key store password*"
 - Djavax.net.ssl.trustStore="*Path to your trust store JKS file*"
 - Djavax.net.ssl.trustStorePassword="*Your trust store password*"
 - DisUseIBMSSLSocketFactory=false
 - For WebLogic, add these properties to the file.
 - Djavax.net.ssl.keyStoreType="JKS"
 - Djavax.net.ssl.trustStore="*Path to your trust store JKS file*"
 - Djavax.net.ssl.trustStorePassword="*Your trust store password*"

If the certificates do not match, the Unica Platform log file contains an error such as the following.

```
Caused by: sun.security.provider.certpath.SunCertPathBuilderException: unable to find valid certification path to
requested target
```

Prerequisites

The Unica Platform must be installed, deployed, and running.

Syntax

```
scheduler_console_client -v -t trigger_name user_name
```

```
scheduler_console_client -s -t trigger_name user_name
```

Commands

-v

List the scheduler jobs configured to listen for the specified trigger.

Must be used with the `-t` option.

-s

Send the specified trigger.

Must be used with the `-t` option.

Options

`-t trigger_name`

The name of the trigger, as configured in the scheduler.

Example

- List jobs configured to listen for a trigger named `trigger1`.

```
scheduler_console_client -v -t trigger1 myLogin
```

- Execute jobs configured to listen for a trigger named `trigger1`.

```
scheduler_console_client -s -t trigger1 myLogin
```

Unica Deliver Response and Contact Tracker (RCT) script

Use this script to run and check the status of the Response and Contact Tracker (RCT).

This script is located in the `bin` directory under your Unica Deliver installation. The Unica Deliver directory is a sub-directory in the Unica Campaign directory.

In UNIX™ or Linux™ environments run the script as `rct.sh`.

In Windows™, run the script from the command line as `rct.bat`.

Syntax

```
rct [ start | stop | check ]
```

Commands

start

Start the RCT

stop

Stop the RCT

Options

check

Check the status of the connection between the RCT and HCL Unica.

Examples

- To start the RCT on Windows™.

```
rct.bat start
```

- To stop the RCT on Windows™.

```
rct.bat stop
```

- In a Linux™ environment, to determine if the RCT is connected to HCL Unica.

```
rct.sh check
```

Depending on the status of your system, the output of this command might look like this:

```
C:\<UNICA_HOME>\Campaign\Deliver\bin>rct check
Testing config and connectivity for partition partition1
Succeeded | Partition: partition1 - Hosted Services Account ID:
asm_admin
```

The MKService_rct script

The MKService_rct script adds or removes the Response and Contact Tracker (RCT) as a service. Adding the RCT as a service restarts the RCT every time you restart the computer where you have installed the RCT. Removing the RCT as a service prevents the RCT from restarting automatically.

This script is located in the `bin` directory under your Unica Deliver installation.

In UNIX™ or Linux™ environments run `MKService_rct.sh` with a user that has root permissions or permissions to create daemon processes.

In Windows™, run the script from the command line as `MKService_rct.bat`.

Syntax

```
MKService_rct -install
```

```
MKService_rct -remove
```

Commands

-install

Add the RCT as a service

-remove

Remove the RCT service

Examples

- To add the RCT as a Windows™ service.

```
MKService_rct.bat -install
```

- To remove the RCT service on UNIX™ or Linux™.

```
MKService_rct.sh -remove
```

Chapter 11. Uninstalling Unica Campaign and Unica Optimize

Run the Unica Campaign and Unica Optimize uninstaller to uninstall Unica Campaign and Unica Optimize. When you run the uninstaller, the files that were created during the installation process are removed. For example, files such as configuration files, installer registry information, and user data are removed from the computer.

About this task

When you install Unica products, an uninstaller is included in the `Uninstall_Product` directory, where *Product* is the name of your product. On Windows™, an entry is also added to the **Add or Remove Programs** list in the Control Panel.

If you manually remove the files in your installation directory instead of running the uninstaller, the result might be an incomplete installation if you later reinstall a product in the same location. After uninstalling a product, its database is not removed. The uninstaller only removes default files that are created during installation. Any file that is created or generated after installation is not removed.

In addition to the general instructions for uninstalling Unica products, follow the guidelines when you uninstall Campaign :

- If you have multiple Unica Campaign runtime installations using the same Unica Platform installation, you must remove network connectivity for the Unica Campaign runtime workstation before you run the uninstaller. Failure to do so uninstalls the configuration data for all the other Unica Campaign runtime installations from Unica Platform.
- You can safely ignore any warnings about failure to unregister with Unica Platform.
- You can export a copy of your configuration as a precaution before uninstalling Unica Campaign.
- If you uninstall the Unica Campaign design time environment, after you run the uninstaller, you may need to manually unregister Unica Campaign. Use the `configtool` utility to unregister `full_path_to_Interact_DT_installation_directory\interactDT\conf\interact_navigation.xml` and `full_path_to_Interact_RT_installation_directory\conf\interact_navigation.xml`.



Note: On UNIX™, the same user account that installed Unica Campaign must run the uninstaller.

1. If you have deployed the Unica Campaign web application, undeploy the web application from WebSphere® or WebLogic.
2. Stop the Unica Campaign listener.
3. To drop the Unica Optimize tables from the system table database, run the `aco_systab_drop.sql` script in the `ddl` directory under your Unica Campaign installation. If the `ddl` directory exists in the product installation directory, run the scripts that are provided in the `ddl` directory to drop tables from the system table database.
4. Shut down WebSphere® or WebLogic.
5. Stop the processes that are related to Campaign.
6. If the `ddl` directory exists in the product installation directory, run the scripts that are provided in the `ddl` directory to drop tables from the system table database.
7. Make sure that the IBM SPSS® Modeler Collaboration and Deployment Service (C&DS) is uninstalled.

Open the Installation Manager and verify that C&DS is uninstalled. If C&DS is not uninstalled, use the Installation Manager to uninstall C&DS.

8. Complete one of the following steps to uninstall Unica Campaign:

Choose from:

- Click the Unica Campaign uninstaller that exists in the `Uninstall_Product` directory. The uninstaller runs in the mode in which you installed Unica Campaign and Attribution Modeler.
- In a command-line window, navigate to the directory where the uninstaller exists, and run the following command to uninstall Unica Campaign and Attribution Modeler by using the console mode:

```
Uninstall_Product -i console
```

- If you are uninstalling on a UNIX™ environment, navigate to the directory where the uninstaller exists, and run the following command to uninstall Unica Campaign:

```
./Uninstall\ Interaction\ History.
```



Note: UNIX™ requires spaces after \.

- In a command-line window, navigate to the directory where the uninstaller exists, and run the following command to uninstall Unica Campaign and Attribution Modeler by using the silent mode:

```
Uninstall_Product -i silent
```

When you uninstall Unica Campaign by using the silent mode, the uninstallation process does not present any dialogs for user interaction.



Note: If you do not specify an option for uninstalling Unica Campaign, the uninstaller runs in the mode in which Unica Campaign is installed.

Chapter 12. Unica Campaign web application clustering

You can configure the Unica Campaign web application (J2EE application) in a cluster by completing additional tasks during the Unica Campaign installation.

You can integrate a Unica Campaign clustered web application environment with Interact, Plan and Deliver.

Overview

The Unica Campaign web application server components support load balancing when the web application is deployed in a clustered environment.

In Unica Campaign, certain objects, such as offers, are cached in the web application server to improve response times in the user interface. In a load balanced environment, offers created on one web application server are available to users whose sessions connect through another server if you have configured `campaign_ehcache.xml`.

The objects that are cached include: offers, offer templates and attributes, campaigns, sessions, folders, attributes, initiatives, and segments.

A clustered configuration can be used to minimize disruptions in application availability in the event of a web application server failure. Because the Unica Campaign system tables are stored in an external database, it is not necessary to replicate data to the standby server. If the primary web application server fails, the Unica Campaign web application must be started on the standby server. When started, the Unica Campaign web application retrieves all current data from the Unica Campaign system table database.

Main steps

To install Unica Campaign in a clustered web application environment, follow the instructions from chapters 2 through 8 and supplement those instructions with information from this chapter.

When you install Unica Campaign in a cluster, there are many ways to configure the installation. The following steps describe the basic process:

1. Run the installers on one system, typically, the administration server or whatever the equivalent is for your application server type.
2. Create and share a file directory to hold the upload files for all of the Unica Campaign installations.
3. Create the EAR or WAR file and deploy it on the cluster and web server.
4. Configure each system to share the Unica Platform system tables and the Unica Campaign system tables.
5. Configure each system to use the shared file directory.
6. Determine which server in the cluster will send notifications. Then, suppress the notification process on all of the other servers.
7. Configure `campaign_ehcache.xml` for distributed caching of templates and offer folders, as explained in the *Unica Campaign Installation Guide*. To specify how often the cache is refreshed, you can adjust the Unica Campaign cache configuration settings, such as `offerTemplateDataTTLSeconds`. However, this adjustment can adversely affect performance because smaller values result in more frequent cache updates. Configuration settings are described in the *Unica Campaign Administrator's Guide*.

WebSphere clustering guidelines

If you are installing Unica Campaign on a cluster in WebSphere®, complete these extra steps in addition to the steps for installing Unica Campaign on WebSphere®.

Preparing the data sources

In addition to any other instructions provided in this guide, complete the following tasks for your data sources:

- The Unica Campaign database must be on a server that is accessible to all servers in the cluster, but it does not need to be on a server in the cluster.
- When you configure the JDBC provider, specify the cluster as the scope.

Installing the products

When you run the installer, be sure that you install Unica Platform and Unica Campaign only once, on a server that is designated as the administration server for the cluster. The administration server is accessible to all servers in the Unica Campaign cluster.

You do not need to install the software on each cluster member. Instead, you install it on the administration server, create the EAR or WAR file, and then deploy the EAR or WAR file on each cluster member.



Note: The IBM® WebSphere® application server that is bundled with Campaign does not support clustering. In a clustered environment, use IBM® WebSphere® Application Server Network Deployment.

Pre-deployment steps

Before you deploy Unica Campaign, complete the following task:

- Share the top-level directory in which Unica Campaign is installed. For example, if you installed Unica Campaign in `C:\CampaignCluster\UNICA\Campaign`, you would share the entire `CampaignCluster` directory.

Deployment steps

In addition to the instructions in the deployment chapter ([Deploying the Unica Campaign web application on page 31](#)), complete the following tasks:

1. Map modules to servers. When you set the options in the **Select Installation Options** wizard for WebSphere®, select the cluster and the web server when mapping modules to servers.
2. Extra instructions for the Generic JVM property: Configure the Generic JVM property on each server in the cluster.

The path that you specify in the `<CAMPAIGN_HOME>` and other properties must point to the shared installation directory.

Set the following extra parameters for clusters:

- Set the following parameter to ensure that Deliver ETL is not triggered by all clustered nodes:

-Dcampaign.deliveretl.disabled=true

For the one node that should trigger ETL Unica Deliver data for all other nodes, set the parameter to **false**.

- Set the following parameter to ensure that Unica Interact ETL is not triggered by all clustered nodes:

-Dcampaign.interactetl.disabled=true

For the one node that should trigger ETL Interact data for all other nodes, set the parameter to false.

Property to enable/disable Journey CH RH in campaign.

Property name: **campaign.journeyetl.disabled**

Supported values: true or false

Default value: false

- **-Dcampaign.journeyetl.disabled=false**

If system property is not present or is set to false, campaign will read CH RH messages from Kafka and dump them in CH RH tables.

- **-Dcampaign.journeyetl.disabled=true**

If system property is set to true, campaign will not read the CH RH data from Kafka and no data will be dumped in Campaign Database.

Post-deployment steps

If you are using a plug-in for load balancing, complete the following configuration steps:

- For Unica Campaign to work effectively in a clustered environment, users must remain on a single node for their entire session. This option for session management and load balancing is known as session affinity. The documentation for your application server provides details about configuring your installation to use session affinity.



Note: When a node fails on a system that uses this configuration option, every user session on that node also fails. The load balancer must not switch users to another available node because user authentication applies only to a single node in Unica Campaign. Users are prompted to log in again. In some cases, an unexpected error and corresponding data loss can occur.

- Log in to Unica Campaign. Select **Settings > Configuration**, and configure the following URL parameters so that all references to the Unica Campaign server use the proxy host and port:

Campaign | navigation | serverURL

Configure ehcache

The `ehcache` is an open source Java™ distributed cache for caching, Java™ EE, and light-weight containers. Every node in the cluster can use the same `campaign_ehcache.xml` file or you can set a different `campaign_ehcache.xml` file for each node. For installations in a cluster, edit the `campaign_ehcache.xml` file so you do not have to restart the computer if you change any templates or offer folders.



Important:



- If your installation is upgraded from a previous version, the `campaign_ehcache.xml` file is overwritten. Add and edit the following sections in the file.
- You must also configure caching for user sessions (`userSessionCache`).

Use one of the following procedures to configure the `ehcache` file.

Configuring ehcache with Remote Method Invocation (RMI)

Unica Campaign systems that have the following topography typically use RMI:

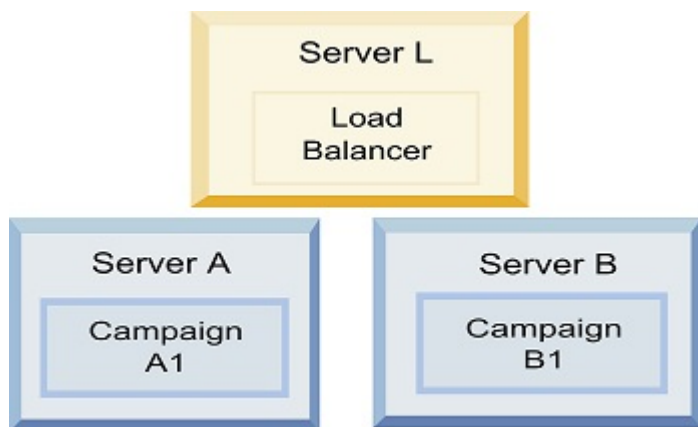

Go to the `<HCL_Unica_HOME>\<CAMPAIGN_HOME>\conf` directory and open the `campaign_ehcache.xml` file in a text editor. Then, make the following edits:

- Uncomment the following section of the file.

You must customize the settings for `machineA` and `machineB` to reflect your environment. Provide a pipe-separated list of all servers in the cluster and use fully qualified host names.

```

<!--<cacheManagerPeerProviderFactory
class="net.sf.ehcache.distribution.RMICacheManagerPeerProviderFactory"
properties="peerDiscovery=manual, rmiUrls=//
<machineA>:40000/campaignApplicationCache|//
<machineB>:40000/campaignApplicationCache|//
<machineA>:40000/userSessionCache|//
<machineB>:40000/userSessionCache"/>
<machineA>:40000/mappingCache
<machineA>:40000/multipartitionOptSessionRunStatusCache
<machineA>:40000/optSessionUserSessionCache
-->
  
```

- Uncomment the following section of the file.

```

<!--
<cacheEventListenerFactory
class="net.sf.ehcache.distribution.RMICacheReplicatorFactory"
properties="replicateAsynchronously=true, replicatePuts=true,
replicateUpdates=true, replicateUpdatesViaCopy=true,
  
```

```

replicateRemovals=true"/>
<cacheEventListenerFactory
class="com.uniacorp.Campaign.cache.CampaignCacheEventListenerFactory" />

<machineA>:40000/mappingCache
<machineA>:40000/multipartitionOptSessionRunStatusCache
<machineA>:40000/optSessionUserSessionCache

-->

```

- Uncomment the following section of the file.

```

<!--
<cacheEventListenerFactory
class="net.sf.ehcache.distribution.RMICacheReplicatorFactory"
properties="replicateAsynchronously=true, replicatePuts=true,
replicateUpdates=true, replicateUpdatesViaCopy=true,
replicateRemovals=true"/>
-->

```

Configuring ehcache with multicast

Unica Campaign systems that have the following topography typically use multicast:

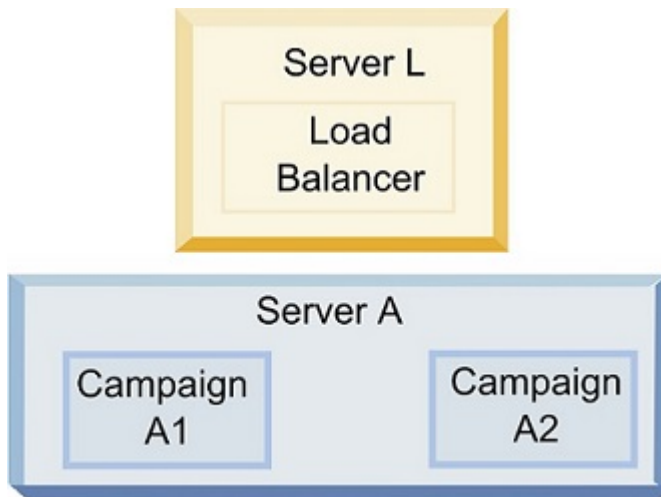

Go to the `<UNICA_HOME>\<CAMPAIGN_HOME>\conf` directory and open the `campaign_ehcache.xml` file in a text editor. Then, make the following edits:

- Uncomment the following section of the file.

You must customize the settings for `multicastGroupAddress` and `multicastGroupPort` to reflect your environment.

```

<!--<cacheManagerPeerProviderFactory
class="net.sf.ehcache.distribution.RMICacheManagerPeerProviderFactory"
properties="peerDiscovery=automatic, multicastGroupAddress=230.0.0.1,
multicastGroupPort=4446, timeToLive=32"/>

<cacheManagerPeerListenerFactory

```

```
class="net.sf.ehcache.distribution.RMICacheManagerPeerListenerFactory"/>
-->
```

- Uncomment the following section of the file.

```
<!--
<cacheEventListenerFactory
class="net.sf.ehcache.distribution.RMICacheReplicatorFactory"
properties="replicateAsynchronously=true, replicatePuts=true,
replicateUpdates=true, replicateUpdatesViaCopy=true,
replicateRemovals=true"/>
<cacheEventListenerFactory
class="com.unicacorp.Campaign.cache.CampaignCacheEventListenerFactory" />
-->
```

Chapter 13. Upgrading to a clustered listener environment



Follow these instructions if you want to upgrade your existing single-listener configuration for Unica Campaign to a clustered listener configuration. A listener cluster is a set of two or more listeners that act as a unit to provide load balancing and high availability. Unica Campaign listener clusters are Active-Active; meaning each node serves requests using the load-balanced approach. Each Unica Campaign listener provides an interface between front-end clients (such as the Unica Campaign web application) and back-end analytical server processes.

1. Confirm that you have met the prerequisites listed in [Supported listener clustering configurations on page 97](#). For example, it is important that a shared file location is already configured and that you have prepared separate machines for each node in the cluster.
2. Follow the instructions in [Planning the Unica Campaign and Unica Optimize upgrade on page 8](#).
3. Familiarize yourself with the material in [Upgrading Unica Campaign and Unica Optimize on page 16](#).
4. Follow the instructions below to upgrade to a clustered listener configuration.

| Step | Description |
|--|--|
| A. Start the installer. | Go to the folder where you saved the Unica installer and run the installer. This invokes all of the product installers that are in that location (Unica Platform, Unica Campaign). |
| B. Upgrade Unica Platform if necessary. | If you have not already done so, complete the screens that upgrade Platform, and click Done on the Installation Complete window. |
| C. Upgrade Unica Campaign in a clustered listener configuration, optionally including the first listener. | <p>The Unica Campaign installer opens. In this installer, you must configure Unica Campaign for a clustered configuration and, optionally, upgrade the first listener in the cluster as well. One listener in the cluster may already be installed on the Unica Campaign server; however, each subsequent listener must be installed on its own standalone server. To upgrade Unica Campaign to a clustered listener configuration, complete the following screens:</p> <ul style="list-style-type: none"> • Introduction • Software License Agreement • Installation Directory • Components: Select the desired options and be sure to select Unica Campaign Server, which is the option to install the listener. • Single or Multiple Listeners: Select Clustered listener configuration (two or more nodes) • Listener Node Properties: "Run Campaign flowcharts" or "Run Optimize Sessions" or "Run Campaign flowcharts and Optimize Sessions both" to install Campaign Analytical Server to serve Campaign or Optimize or both. • Complete the following screens to upgrade the first listener: |

| Step | Description |
|---|--|
| | <ul style="list-style-type: none"> ◦ Shared Network File Location. The clustered listener configuration requires that certain files and folders are shared and accessible to all of the listeners in a cluster. Use this screen to specify the path to the shared file location. Use a mapped Microsoft Windows server path (such as Z:\Campaign_Shared) or a mounted UNIX path (such as /mnt/Campaign_Shared). This location is known as the <code>campaign-SharedHome</code>. ◦ Move Listener files to the Shared Network Location. Choose Automatic (recommended) or Manual. If you choose Automatic, the installer copies partition data to the <code>campaign-SharedHome</code> location. If you choose Manual, you must manually copy the partition[n] data to <code>campaignSharedHome</code>. ◦ Listener Node Properties. For each listener node that you install in a cluster, you must specify properties such as a unique name for the node, the node's network host and port, and so on. ◦ Master Listener Priority. The priority determines which node in the listener cluster is the master listener and which node to use in the event of failover. ◦ Load Balancing Weight. The weight determines how much listener traffic the node can support to share processing with the other nodes. Specify any value other than zero because a value of zero prevents the node from handling any listener connections. |
| <p>D. Continue with the upgrade process.</p> | <p>From this point in the upgrade process, the remaining screens are essentially the same as for a single-node upgrade. When you complete the Pre-installation Summary screen, click Install to complete the upgrade of Unica Campaign and the first listener node in the cluster.</p> <p>The Unica Campaign installer runs with the options that you specified.</p> <p>If you selected Automatic for Move Listener files to the Shared Network Location, certain files are moved from the original installation directory to the <code>campaignSharedHome</code> directory structure. Unica Campaign-related objects (such as <code>.ses</code> files and <code>.dat</code> files) are now located under the shared partition location, not the local installation location. For details, see Shared network location for clustered listeners: campaignSharedHome on page 99.</p> |
| <p>E. Run the acUpgrade tool.</p> | <p>Run the acUpgrade tool as described in Running acUpgradeTool on page 27 and complete any additional upgrade tasks before continuing.</p> |

| Step | Description |
|---|--|
| F. Deploy and package the EAR file. | <p>For the first installer node in the cluster, which you are installing on the main Unica Campaign server, the installer displays screens to deploy and package the EAR file, the same as for a single-node installation.</p> <p>Continue with the process of deploying and running Unica Campaign in your web application server, and running the listener on the Unica Campaign server.</p> |
| G. Install the second node in the cluster. | <p>If you have not already done so, copy the Unica master installer and the Unica Campaign installation files onto the server where your next Unica Campaign installer node will run, and launch the master installer.</p> |

| Step | Description |
|--|--|
| <p> Important: Each listener node must be installed on a separate machine.</p> | <p>In the master installer, provide the information necessary to connect to the Unica Platform database, exactly the same way as for the first listener that you installed. Each listener in the same cluster must use the same master installer configuration.</p> <p>When the Unica Campaign installer appears, complete the screens described here:</p> <ul style="list-style-type: none"> • Introduction • Software License Agreement • Installation Directory • Campaign Components: Select only Campaign Server, because you are only installing the listener on this system. • Single or Multiple Listeners: Select Clustered listener configuration (two or more nodes) • Complete the following screens to install the second listener: <ul style="list-style-type: none"> ◦ Shared Network File Location. The clustered listener configuration requires that certain files and folders are shared and accessible to all of the listeners in a cluster. Use this screen to specify the path to the shared file location. Use a mapped Microsoft Windows server path (such as Z:\Campaign_Shared or \\hostname.example.com\Campaign_Shared) or a mounted UNIX path (such as /mnt/Campaign_Shared). ◦  Note: The value that you enter here must be the same for every listener in the cluster. ◦ Listener Node Properties. For each listener node that you install in a cluster, you must specify properties such as a unique name for the node, the node's network host and port, and so on. ◦ Master Listener Priority. The priority determines which node in the listener cluster is the master listener, and the priority used to determine which node to use in the event of failover. ◦ Load Balancing Weight. The weight determines how much listener traffic the node can support for sharing the processing with the other nodes. Specify any value other than zero, because a value of zero prevents the node from handling any listener connections. <p>From this point in the installation process, the remaining screens are essentially the same as for a single-node install. When you complete the Pre-installation Summary screen, click Install to complete the installation of Unica Campaign and the first listener node in the cluster.</p> <p>The Unica Campaign installer runs with the options that you specified.</p> |
| <p>H. Start the Unica Campaign listener on the second node</p> | <p>When the installation is complete, start the Unica Campaign listener. See Starting the Unica Campaign server on page 27.</p> |

| Step | Description |
|---|--|
| I. Install each subsequent node in the cluster. | Repeat the installation steps that you performed for the second listener node for each additional node that you want to install. Remember that each node must be installed on a separate system from the other nodes. Start the listener on each node as you complete its installation. |
| J. This step is required only if you did a Manual update. | If you did an Automatic update, skip this step. If you selected Manual for Move Listener files to the Shared Network Location , set up the <code>campaignSharedHome</code> folder structure as described above, and copy the required files from the local installation directory to the <code>campaign-SharedHome</code> . |
| K. Adjust configuration settings, then restart the web application server and listeners. | Log in to Unica Campaign and set the following configuration properties: <ul style="list-style-type: none"> • Campaign campaignClustering: Set enableClustering to TRUE. • Campaign campaignClustering: Set campaignSharedHome to the Shared Network File Location (<code>campaignSharedHome</code>) that you specified during the upgrade. <p>Configuration properties are explained in the Unica Campaign Administrator's Guide.</p> <p>Be sure to restart the web application server and the listeners.</p> |

Results

You have now upgraded to a clustered listener configuration.

Supported listener clustering configurations

This topic pertains to a clustered listener configuration.

Prerequisites and requirements for Unica Campaign listener cluster configurations:

- There can be only one listener per physical host machine.
- All back-end machines for clustered listeners must be running the same operating system type.
- All back-end machines for clustered listeners must have the same version of Unica Campaign installed.
- The shared network location (`campaignSharedHome`) must be in place and must be accessible from each physical host machine on which you plan to install a listener node. You must set this up prior to installing the listener nodes.
- `listenerType` –Campaign Listener when installed in cluster mode, `ListenerType` plays an important role to decide which listener should execute Campaign flowcharts or Optimize session or both.
 - `ListenerType` - 1 - Run only Campaign flowcharts
 - `ListenerType` - 2 - Run only Optimize sessions
 - `ListenerType` - 3 - Run Campaign flowchart and Optimize session

These `listenerType`s are set based on the option selected while installing Campaign listener. Users can switch between these values at any time and restart the application to reflect this.

Diagram of listener clustering

This diagram illustrates a three-node listener cluster configuration.

 **Note:** The following summary provides a high-level overview of the components. Details are provided in separate topics.

A cluster consists of multiple listener nodes. Each node (unica_aclsnr) is on a separate physical machine, and each node has a native ODBC connection to the Unica Campaign system database. As with a single-node configuration, each unica_aclsnr process spawns additional back-end processes for logins and flowcharts.

Each node also has a connection to a back-end user database (not shown in diagram).

In a clustered configuration, one node acts as the master listener. The job of the master listener is to perform load balancing by distributing incoming requests to each node. The Unica Campaign web application sends client requests over TCP/IP, and the load balancer component communicates with clustered nodes over TCP/IP. All nodes share a network file system, so they can access shared files. Additionally, each node has its own local tmp folder and its own set of files that are not shared.

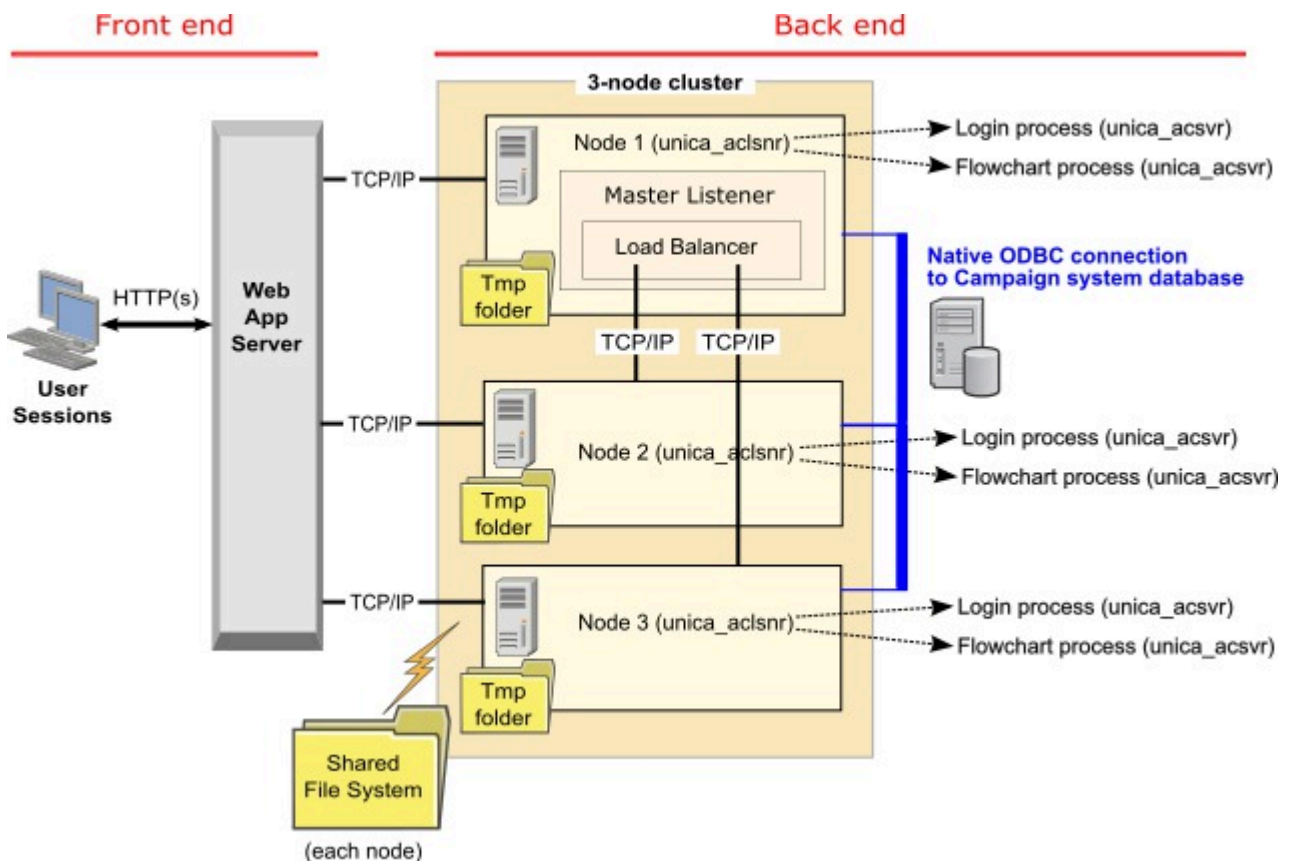

Shared network location for clustered listeners: campaignSharedHome

A clustered listener configuration for Unica Campaign requires that certain files and folders must be shared and accessible to all listeners in a cluster. Therefore, you must have a shared file system in place.

Requirements

- The common area can be a machine or location that is accessible from all other machines in the listener cluster.
- Each listener in a cluster must have full access to the shared files and folders.
- Best practice is for all listeners to be on the same network, and for the shared home to also be on that network, to avoid latency issues.
- To avoid any single point of failure, the shared file system should use mirrored RAID or an equivalent method of redundancy.
- If you are installing a single-listener configuration, a shared file system is a best practice, in case you decide to implement listener clusters in the future.

Shared files and folders

In a clustered configuration, all listeners share the folder structure shown below. The shared location (`<campaignSharedHome>`) is specified at installation time and is configurable at **Campaign|campaignClustering|campaignSharedHome**. The shared partition contains all logs, campaigns, templates, and other files.

```
campaignSharedHome
|--->/conf
|-----> activeSessions.udb
|-----> deadSessions.udb
|-----> etc.
|--->/logs
|-----> masterlistener.log
|-----> etc.
|--->/partitions
|-----> partition[n]
|-----> {similar to <Campaign_home> partition folder structure}
```

Files and folders that are not shared

Each Unica Campaign listener has its set of folders and files that are not shared, under `<Campaign_home>`. `Campaign_home` is an environment variable that represents the Unica Campaign application installation directory. This variable is set in `cmpServer.bat` (Windows™) or `rc.unica_ac.sh` (UNIX™). Partitions are specific to the local listener. Each local partition folder contains a `tmp` folder for temporary files during flowchart runs and a `conf` folder for the table manager cache file.

```
Campaign_home
|--->/conf
|-----> config.xml
|-----> unica_aclsnr.pid
|-----> unica_aclsnr.udb
|-----> etc.
|--->/logs
|-----> unica_aclsnr.log
|-----> etc.
|--->/partitions
|-----> partition[n]
|-----> /tmp
```

```
|----->/conf  
|----->{other files specific to the partition}
```